



VLA Compact Line Array (VLA-C) Calculator

V1.1.0

INTRODUCTION

Welcome to the JBL VLA Compact (VLA-C) Line Array Calculator. We hope you will find it to be a useful simulation software tool that will enable you to obtain even higher levels of performance from your VLA Compact loudspeaker system.

Installing VLA Compact Calculator

Before installing the VLA-C Calculator, uninstall all previous versions using the Windows® Control Panel to Add/Remove programs. After un-installing older versions, unzip the VLA-C Calculator distribution file and then run the “setup.exe” program. Your computer will need to have the latest version of Microsoft .NET 4 (the installer will download this automatically if your computer requires an update). JBL’s VLA-C Calculator requires a PC with Windows XP or newer. Recommended screen resolution is 1024 x 768 (minimum).

ACOUSTICAL MAPPING TAB

The Acoustical Mapping tab allows for definition of the following parameters:

- Units (metric or imperial)
- Air absorption parameters (temperature and humidity) under “Options”
- Room dimensions in XY coordinates (X = distance, Y=elevation) or distance/angle
- Array location and elevation
- Number of enclosures
- Enclosure type
- Inter-enclosure angles
- Array site angle
- Enclosure: gain, delay, EQ (graphic or parametric, plus whether front or rear facing for VLA-C125S subwoofers)

The following acoustical prediction results are displayed:

- SPL Mapping (selectable individual frequencies from 20 Hz – 10 kHz)
- 0 dB Isobars (up to 4 frequencies simultaneously)
- SPL Attenuation (up to 4 frequencies simultaneously)
- Frequency response (up to 6 probe locations)

Parameter definition and acoustical predictions are discussed in more detail in the following.

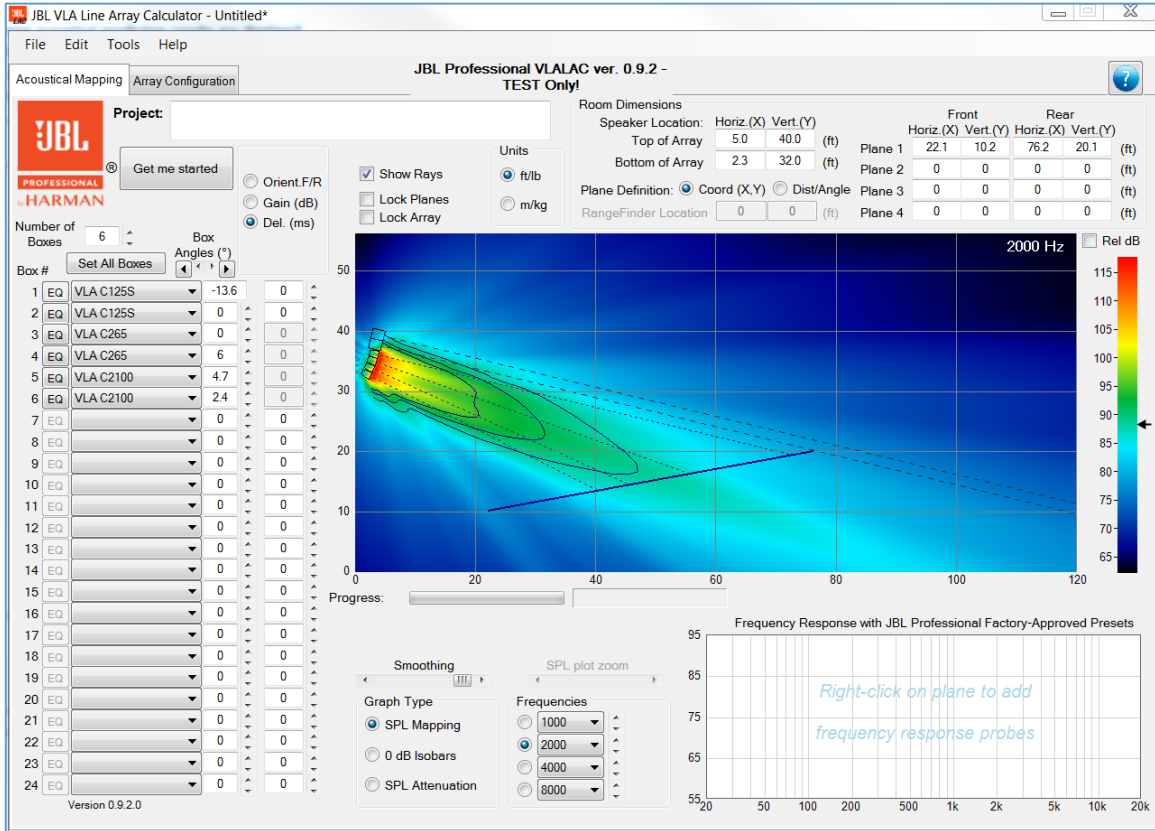

Units:

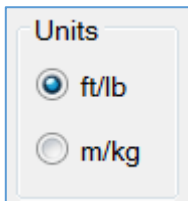

Selected the desired units by clicking on either ft/lb or m/kg. Values are updated accordingly.

Air Parameters (through the “Options” tab):

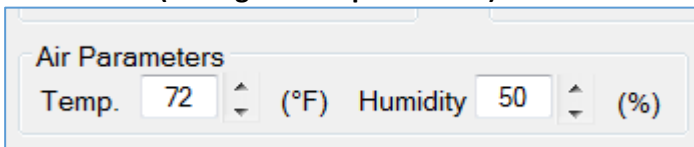

Enter the desired Temperature (°F or °C) and % Humidity. The VLA-C Calculator calculates atmospheric attenuation based on ISO 9613-1.

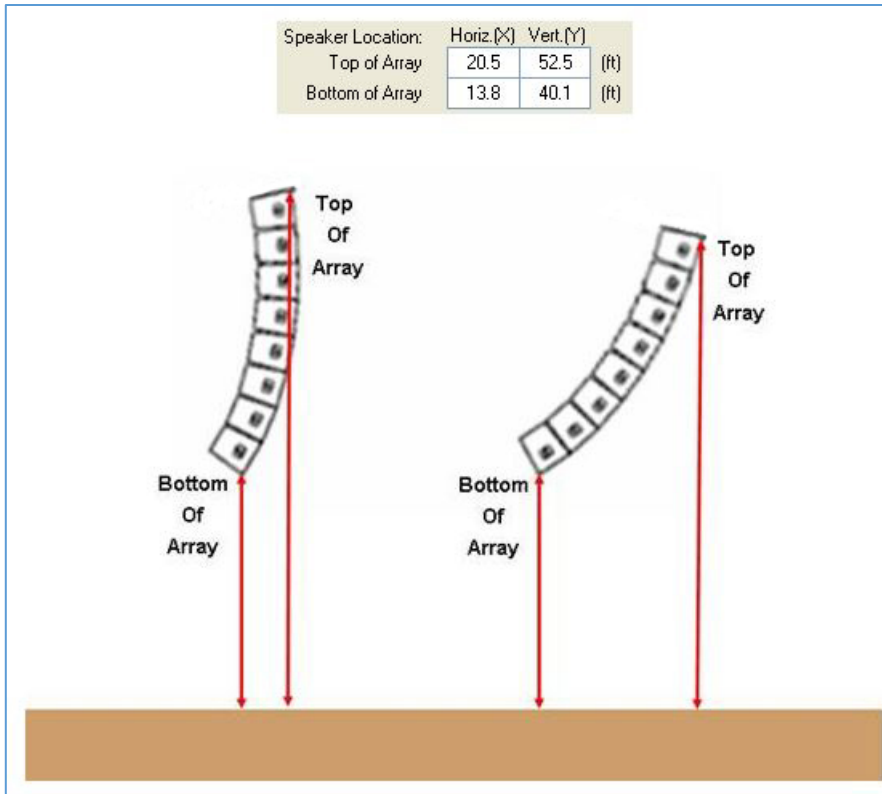

DEFINING THE AUDIENCE PLANES

Plane Definition: Coord (X,Y) Dist/Angle

Select "Coord (X,Y) or "Dist/Angle" to toggle between plane definition modes.

Coord (X,Y) Mode:

Audience listening planes can be entered graphically (see: Graphical Adjustment of Planes) or manually in the "Room Dimensions" cells in terms of XY coordinates (X = distance/range, Y = elevation/height). In the example below, the origin is set at the intersection between floor level (Y=0) and the downstage edge (X=0). Always take into account the audience listening level (ear height) when defining audience planes. For seated audiences, ear level is 4 ft (1.2 m) and for standing audiences approx 6 ft (1.8 m).

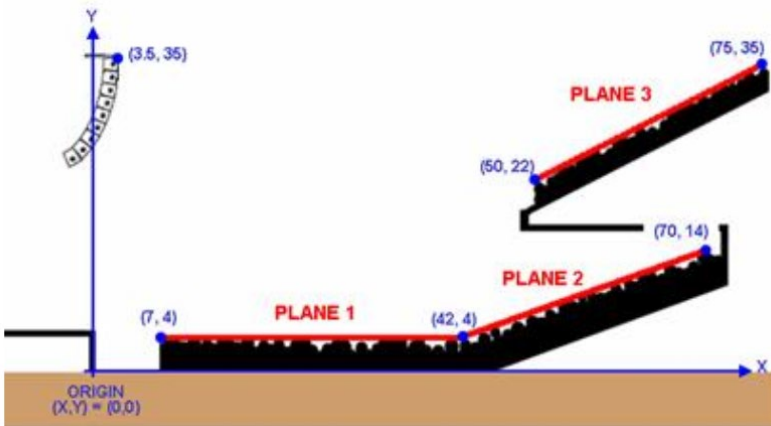
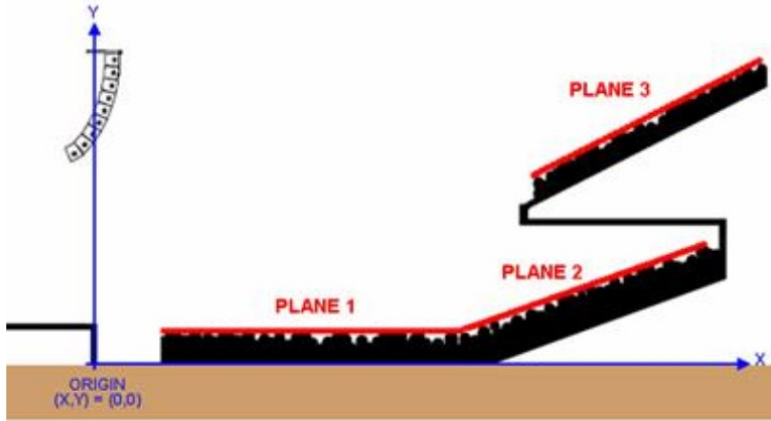

Room Dimensions		Speaker Location:		Front		Rear	
	Horiz.(X)	Vert.(Y)		Horiz.(X)	Vert.(Y)	Horiz.(X)	Vert.(Y)
Top of Array	3.5	35	(ft)				
Bottom of Array	-2.2	22.4	(ft)				
Plane 1	7	4	(ft)	42	4		
Plane 2	42	4	(ft)	70	14		
Plane 3	50	22	(ft)	75	35		
Plane 4	0	0	(ft)	0	0		

Plane Definition: Coord (X,Y) Dist/Angle
 RangeFinder Location: (ft)

Distance/Angle Mode:

Planes can be entered in terms of distance and angle, allowing measurements to be taken on-sight with a laser rangefinder and inclinometer. The rangefinder/inclinometer location should first be defined in terms of XY coordinates (a yellow cursor is displayed in the Acoustical Mapping window to show its location). For the example below, the rangefinder/inclinometer is tripod-mounted on the stage with XY coordinates = (0,6). It is also possible to left-click, drag-and-drop to move the rangefinder location in the Acoustical Mapping plot window, as desired.

Distance Measurement:

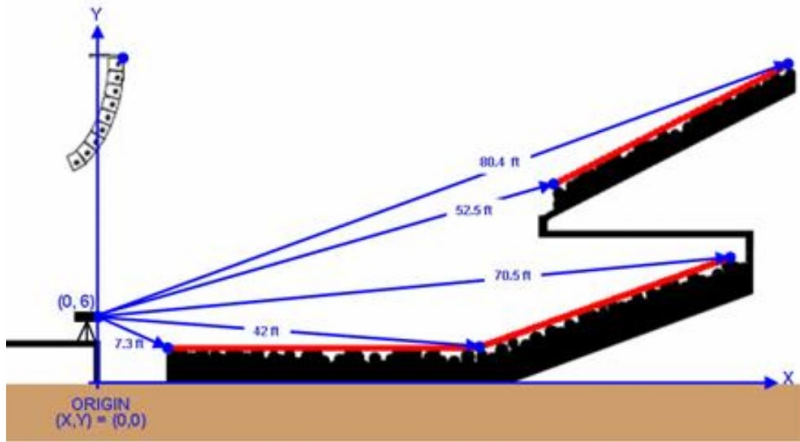

Angle Measurement:

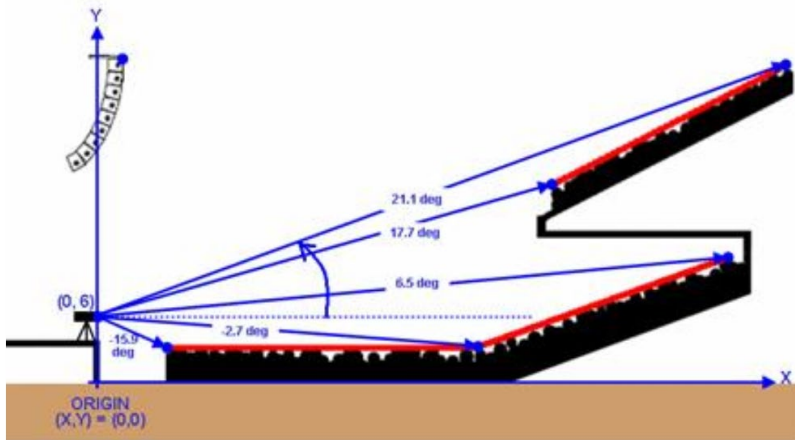

Room Dimensions

Speaker Location:	Horiz.(X)	Vert.(Y)			Front	Rear	
	Dist.(ft)	Angle(°)	Dist.(ft)	Angle(°)	Dist.(ft)	Angle(°)	
Top of Array	3.5	35 (ft)	Plane 1	7.3	-15.9	42.0	-2.7
Bottom of Array	-2.2	22.4 (ft)	Plane 2	42.0	-2.7	70.5	6.5
Plane Definition: <input type="radio"/> Coord [X,Y] <input checked="" type="radio"/> Dist/Angle			Plane 3	52.5	17.7	80.4	21.1
RangeFinder Location	0	6 (ft)	Plane 4	0	0	0	0

DEFINING ARRAYS

Arrays can be defined on either Acoustical Mapping or Array Configuration pages. Up to 24 enclosures* can be defined along with enclosure: type, EQ, gain, delay; array sight angle (equivalent to Box #1 angle); and inter-enclosure angles (adjustment via nudge buttons).

By default, four VLA-C265 enclosures are loaded with 1.5 degree inter-enclosure angles:

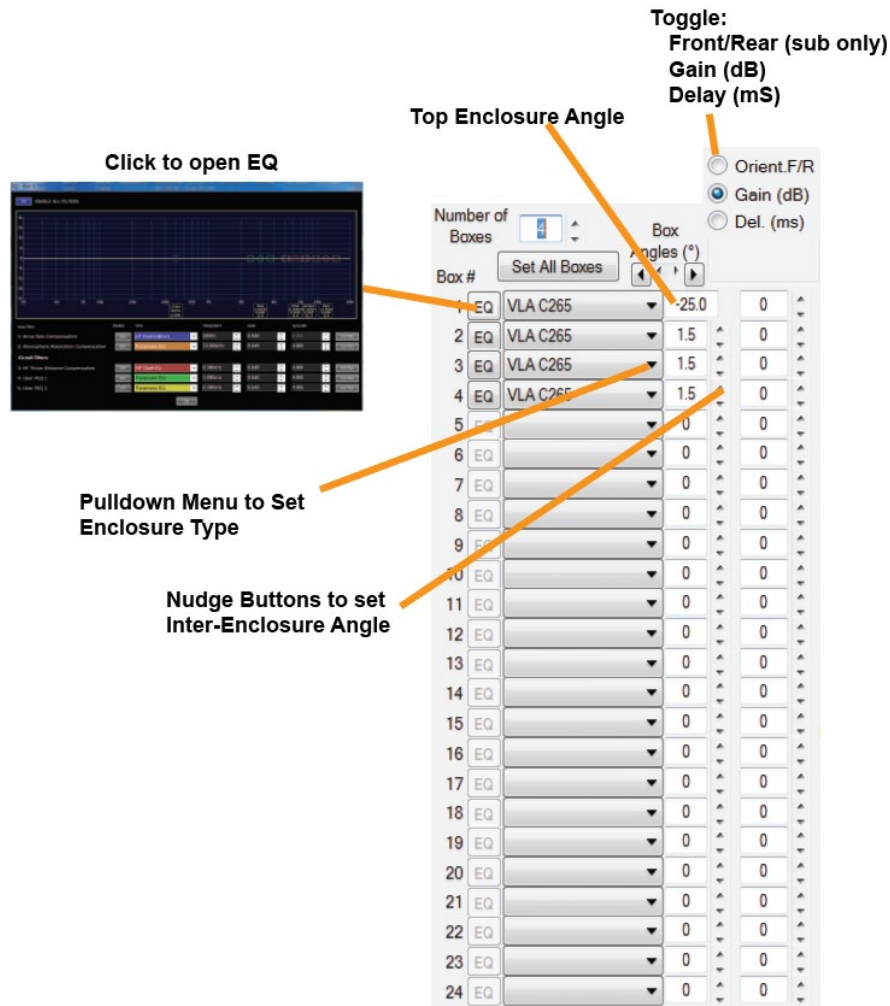

** Exact suspension limits depend on enclosure type(s), array size, array shape, overall array orientation and the selected array frame attachment configuration. Always refer to warning indications on the Array Configuration page. Overhead suspension of loudspeaker systems should be undertaken only by trained and qualified personnel. JBL Professional is not responsible for the use, misuse or misapplication of these products.*

SELECTING INTER-ENCLOSURE ANGLES

Once the vertical section of the audience profile has been defined, the goal in selecting the number of enclosures and angles between enclosures is to ensure that the audience is covered from front to rear of the defined audience profile with equal spacing between enclosure site angle impacts (rays) over the audience profile. *Note: for long throw applications, reduced enclosure impact spacing may be desirable for the upper enclosures of the array.* Once coverage and enclosure site angle spacing is correct, further optimization can be performed by applying circuit level gain shading and frequency tapering (equalization on a circuit basis using shelving eq filters available in the JBL Line Array Control Panel through the EQ button).

The “Get Me Started” feature implemented provides a useful starting point for further manual optimization. Provided that a sufficient number of enclosures is specified to cover the audience from

front to rear, the Get Me Started feature will determine inter-enclosure angles that provide equal site angle impact spacing:

GET ME STARTED – BEFORE

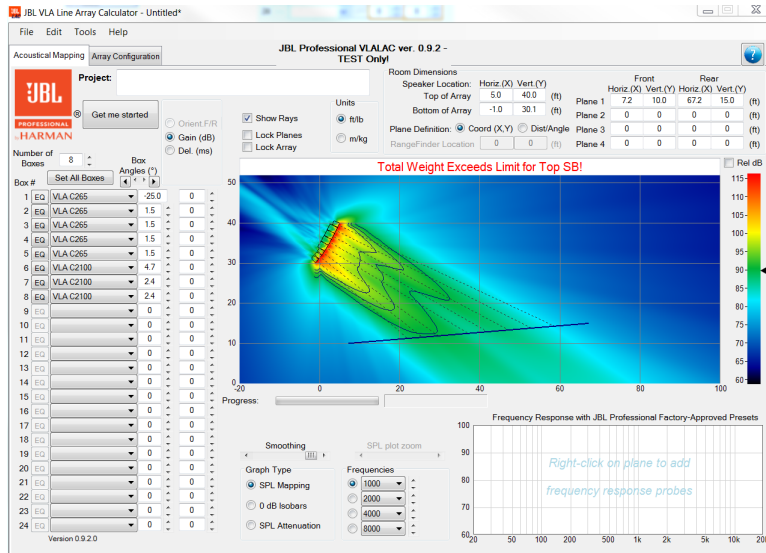

GET ME STARTED – AFTER

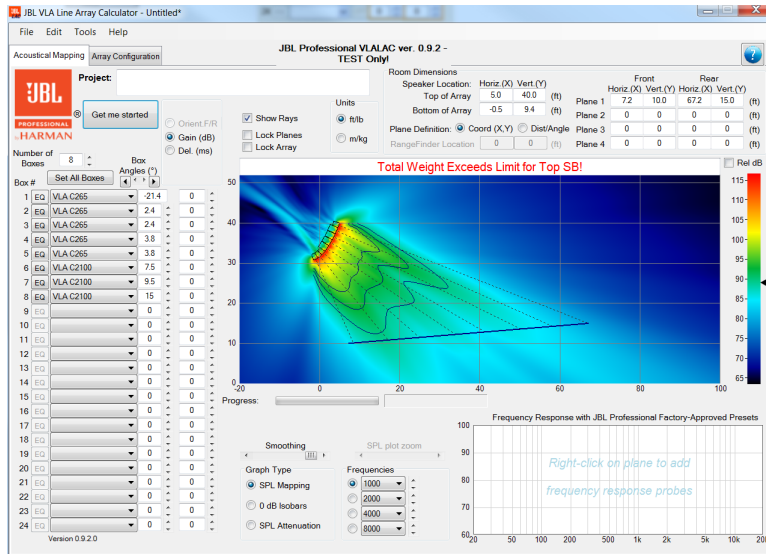

Gain can be adjusted in 0.5 dB steps and delay in 0.022 millisecond (ms) increments. Note: Delay adjustment is recommended for Electronic Delay Steering (EDS) of subwoofer arrays only -- Delays are pre-defined and linked for VLA-C265 and VLA-C2100 enclosures.

FILTER EQ

The frequency response of a line array is determined by many factors including the array size (number of boxes), array curvature, and the listening distance. JBL factory presets were designed to create an appropriate tonal balance starting point for the array conditions described above. Since the number of presets that can be created by a manufacturer is not infinite, user adjustment of certain DSP parameters

is necessary to create the desired tonal balance for a given array and application. This EQ was designed to help system engineers quickly and easily manipulate the tonal balance of an array.

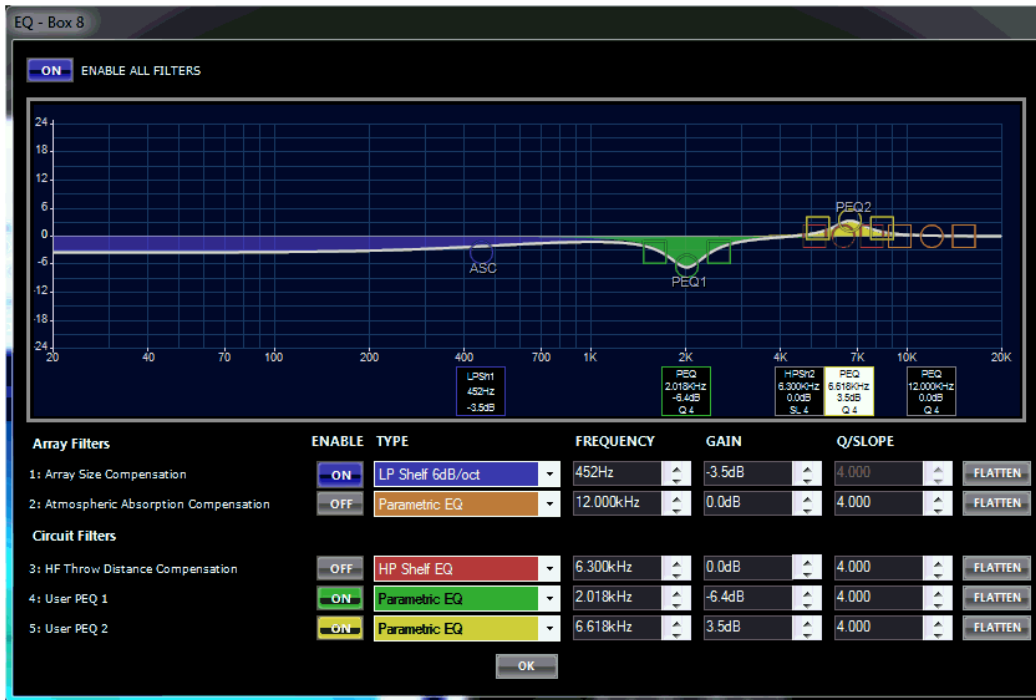

This EQ consists of 5 adjustable DSP filters, each with a specific intended purpose. Some of these filters are grouped across the entire array (global adjustments), some filters are circuit group specific, and some filters have frequency centers and Q values that are linked but have adjustable circuit gain. Below is a description of how these filters work:

Array Size Compensation: Filter 1 is intended for correcting LF/MF build up created by an array that is longer than the intended preset. LF adjustments should be applied to all cabinets within the array, therefore filter 1 is a global filter (affecting all enclosures in the array).

Atmospheric Absorption Compensation: Filter 2 is intended to compensate for atmospheric conditions due to large variations in temperature and humidity that can have an impact on the overall HF energy. This filter is applied globally (to all the enclosures in the array) and can be used to quickly brighten or darken an array. It can also be used for artistic preference reasons to adjust overall system tonal balance.

HF Throw Distance Compensation: Filter 3 along with Gain shading is intended to correct for distance offsets between different sections of an array. The Type, Frequency and Q are linked across the entire array but the gain is adjustable per circuit (ie, per enclosure individual or set of enclosures that are on the same amplifier channel). This filter can be used to reduce HF energy close to an array and increase HF energy to areas further away where air absorption has a bigger impact.

User PEQ 1 & 2: Filters 4 and 5 are User PEQs that can be applied to individual circuit groups (ie, per enclosure individual or set of enclosures that are on the same amplifier channel). Frequency centers and Q are not linked across circuits and, for this reason, it is recommended that User PEQ 1 & 2 are used for frequencies above 1kHz with moderate gain changes only.

SUBWOOFER MODELING

Cardioid Subwoofer Systems

A cardioid subwoofer system is where one of the subwoofers (typically one out every three enclosures) is reversed to face toward the rear to cancel out some of the subwoofer sound projecting in toward the rear of the array. Some adjustments need to be made to the setting of the rear-facing subwoofer in order to make it work properly. To simulate reverse cardioid (gradient) subwoofer arrays, additional polarity and orientation parameters are available in the LVA-C Calculator. When a subwoofer's orientation is reversed to rear-firing, polarity is automatically inverted and the appropriate delay and EQ are applied to the rear-firing enclosure. Since rear-firing cardioid delays (as implemented in cardioid preset output processing blocks) are included in the LAC II simulation, default delay values are displayed as 0.0 msec.

Selecting VLA-C125S versus VLA-C125-LF

Whether the VLA-C125S subwoofers are going to act as subwoofers or as low-frequency loudspeakers is selected via the Preset box located below the main graphic display. This corresponds with the VLA-C125S-LF and VLA-C125S sub DSP settings you select in the amplifier DSP setting presets. The VLA-C125S-LF setting raises up the low-pass crossover frequency to allow the subwoofers to extend higher in frequency.

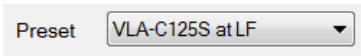

DEFINING MIXED ARRAYS

Mixed arrays can be created by selecting the desired enclosure types from the pulldown menu on either Acoustical Mapping or Array Configuration pages.

GRAPHICAL ADJUSTMENT OF PLANES AND ARRAYS

Adding and Deleting Audience Listening Planes

Planes can be added by "right clicking" on an area of the window that does not correspond to a loudspeaker array. A context menu will appear, allowing a plane to be added. The seating plane will appear approximately where the right click occurred, closest to the nearest existing plane.

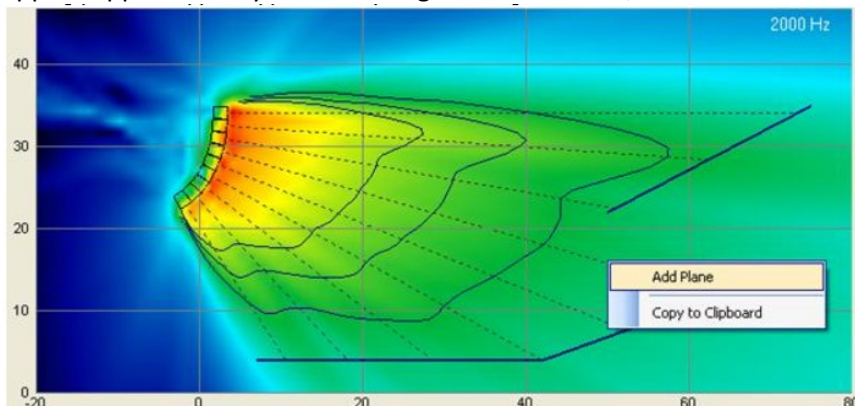

After a seating plane is added, left-click, drag-and-drop in the center of the plane to move it around or left-click, drag-and-drop the ends to adjust the plane (see the following section for further details).

To delete a plane, hover the cursor over the plane until it highlights red, then right-click and a context menu will appear allowing the plane to be removed:

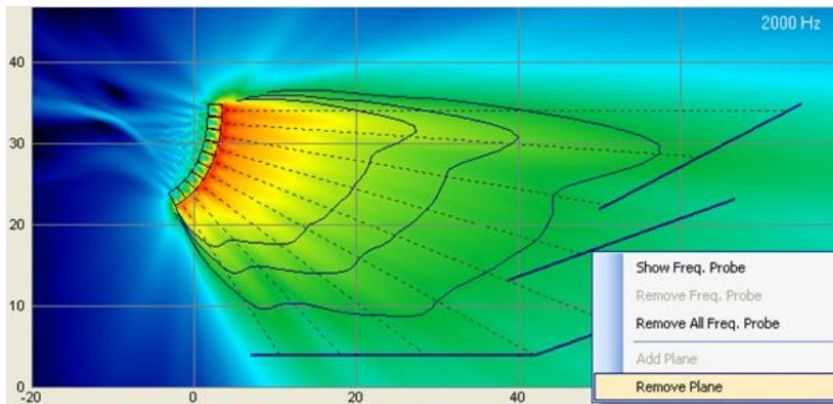

Locking Audience Planes and Array Location

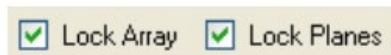

Moving and Adjusting Seating Planes

If “Lock Planes” is not selected:

When the cursor is hovered over either end of an audience plane, a circular cursor will appear and it is possible to left-click, drag-and-drop that end of the seating plane to resize it. When the cursor is hovered over the middle of an audience plane, a circular cursor will appear and it is possible to left-click, drag-and-drop the entire plane. If the seating plane is dragged or resized so that it is outside of the “display window”, the graphics display will automatically rescale.

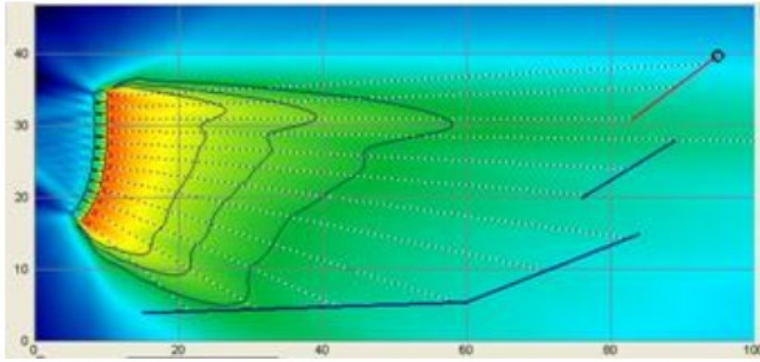

Top of Upper Balcony Plane Selected

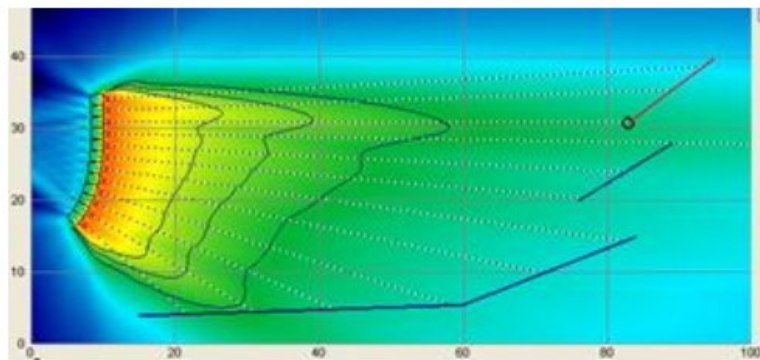

Bottom of Upper Balcony Plane Selected

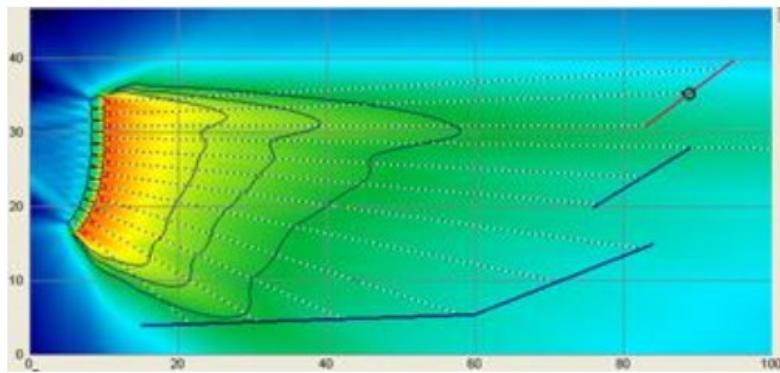

Entire Upper Balcony Plane Selected

Moving and Aiming the Speaker Array

If "Lock Array" is not selected:

When the cursor is hovered over the top front corner of the top enclosure of the array, a circular cursor will appear and it is possible to left-click, drag-and-drop the entire array in the window:

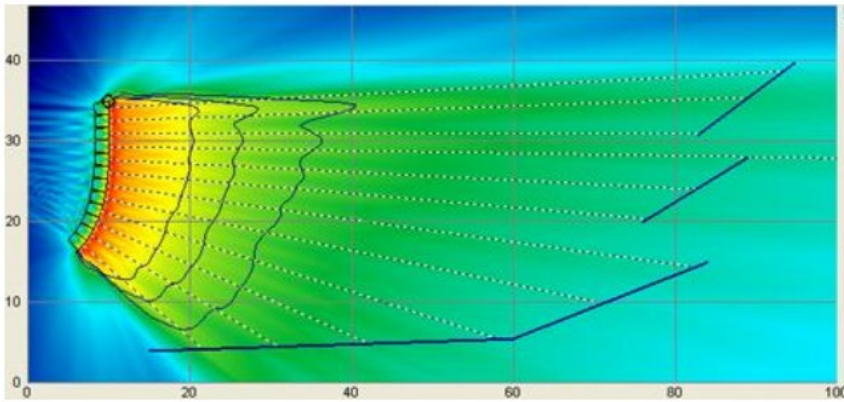

When the cursor is hovered over the bottom front corner of the bottom enclosure of the array, the overall aiming angle or sight angle for the entire array can be changed via left-click, drag-and-drop. The entire array will pivot about the top front corner of the top box as the bottom front corner is dragged-and-dropped.

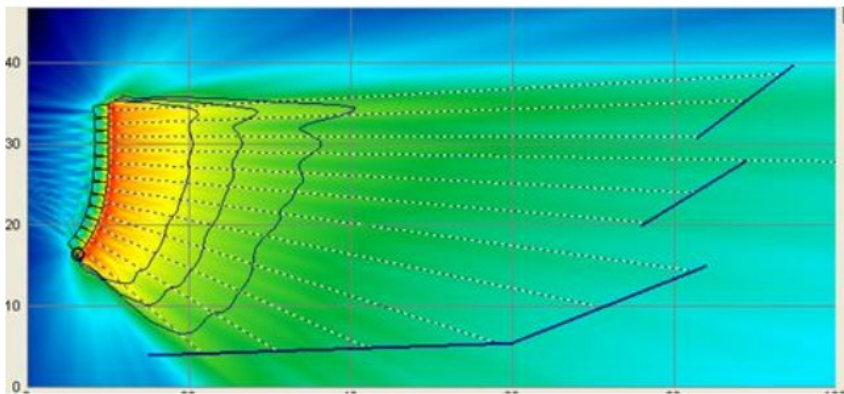

If the speaker cluster is dragged or rotated to the left of the “zero” horizontal coordinate, the graphics window will automatically rescale.

Alternatively, it is possible to left-click, drag and drop on enclosure site angle reference lines (rays) to select angles between enclosures. Selecting the ray for the top enclosure adjusts the overall site angle of the entire array:

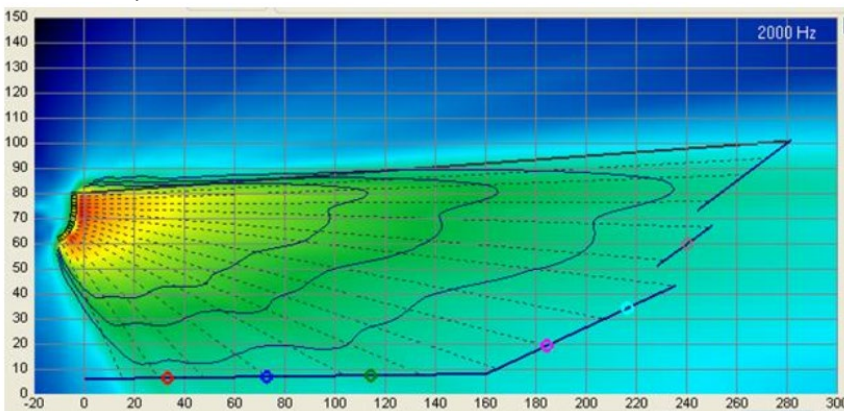

Top enclosure ray selected / highlighted: allows for array site angle adjustment (drag and drop)

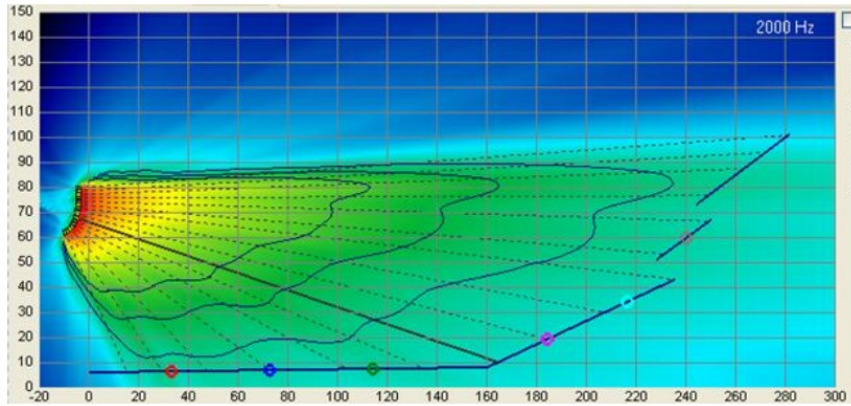

Enclosure ray selected / highlighted: allows for inter-enclosure angle adjustment (drag and drop)

SPL MAPPING VIEW

The rated sensitivity and electrical power handling and gain selections are used to determine the maximum peak SPL for the frequency of interest, providing an indication as to available system headroom.

Isobar lines display constant SPL contours at the selected frequency and are shown in dark blue for 0 / +3 / +6 dB (default values). Isobars provide a convenient way to visualize relative attenuation and pressure gradients between the loudspeaker array and defined audience listening planes. Scale of the Isobars can be changed to: 0 / +2 / +4 dB or 0 / +1 / +2 dB from the “Tools → Options” menu. Isobar smoothing can be adjusting using the horizontal “Smoothing” slider located below the graphics window.

Left-click on the SPL Mapping view to display the SPL and the XY coordinate at the selected location.

Selecting the “Rel dB” check box to the right of the display window will normalize the SPL mapping so that 0 dB is the loudest location on all seating planes.

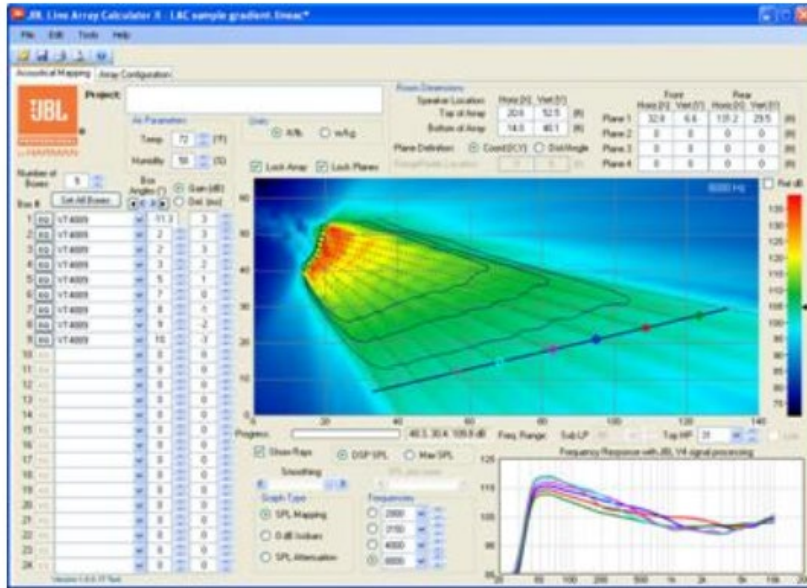

Modifying Factors for SPL

- The SPL shown in the Frequency Response chart is based on the full rated power input to each cabinet as specified on the model's specification sheet, as modified by whatever gain reduction you've got selected in the "Gain (dB)" selection boxes.
- The SPL shown is exclusive of power compression from the transducers. Power compression occurs when heat from high drive levels causes the impedance of the driver's voice coils to increase, thereby reducing power draw from the supplied amplifier voltage. Power compression varies with time duration and duty cycle of the program material. Such dynamic factors are not shown in steady-state modeling software and is not reflected in the indicated SPL figures. The VLA-C model's NDD (Neodymium Differential Drive™) transducers tend to dissipate heat better than traditional transducers, so power compression tends to be lower, however as with all loudspeakers, power compression can increase with drive level and time duration and can reduce the overall maximum SPL of the system compared to what is shown.
- The SPL computations in the modeling presumes that all frequency bands are hitting the limiter voltage at the same time, which may not be the case. If the combination of the program content and the filter EQs is such that a particular frequency band reaches the limiter voltage before other bands, then the full-band SPL may not reach the indicated SPL level due to limiter activation.

0 dB ISOBAR VIEW

The "0 dB Isobar" view allows the pressure gradient of up to four frequencies to be simultaneously displayed on the same plot. The highest SPL for any of the seating planes shown in the mapping view is displayed as the 0 dB reference level. The relative distance of the isobar from the seating plane provides

an indication of the variation in SPL immediately perpendicular to the plane. Selected frequencies are shown in the top right corner of the display window.

Smoothing of the 0 dB Isobar view can be adjusted using the slider control labeled “Smoothing”.

All other graphical controls for planes, loudspeaker array location and aiming are as previously described.

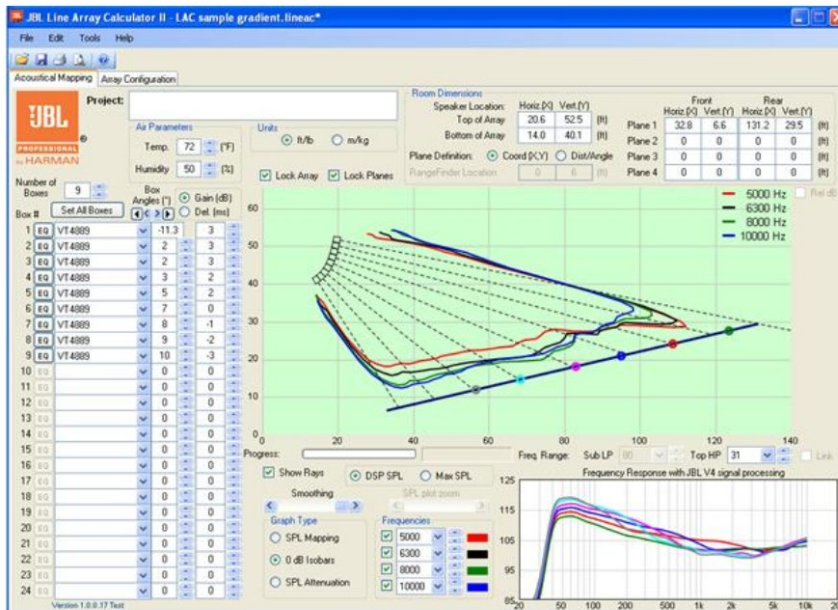

SPL ATTENUATION VIEW

The “SPL Attenuation” view shows relative SPL level along each of the listening planes at up to four frequencies simultaneously. This view provides a quick, at-a-glance indication of SPL variation along the entire length of the audience planes and is a useful representation for array gain shading and frequency tapering (i.e., equalization as implemented using Box EQ).

Darker green lines are equally-spaced between the listening plane and the loudspeaker array and indicate 3 dB, 6 dB and 9 dB of attenuation relative to the 0 dB attenuation reference corresponding to the seating plane. As seen in the example below, all SPL contours fall within the listener plane and the -3 dB reference, corresponding to a variation of +/- 1.5 dB along the audience plane.

The relative scale (or spacing) between attenuation lines can be adjusted using the “SPL plot zoom” horizontal slider control.

All other graphical controls for planes, loudspeaker array location and aiming are as previously described.

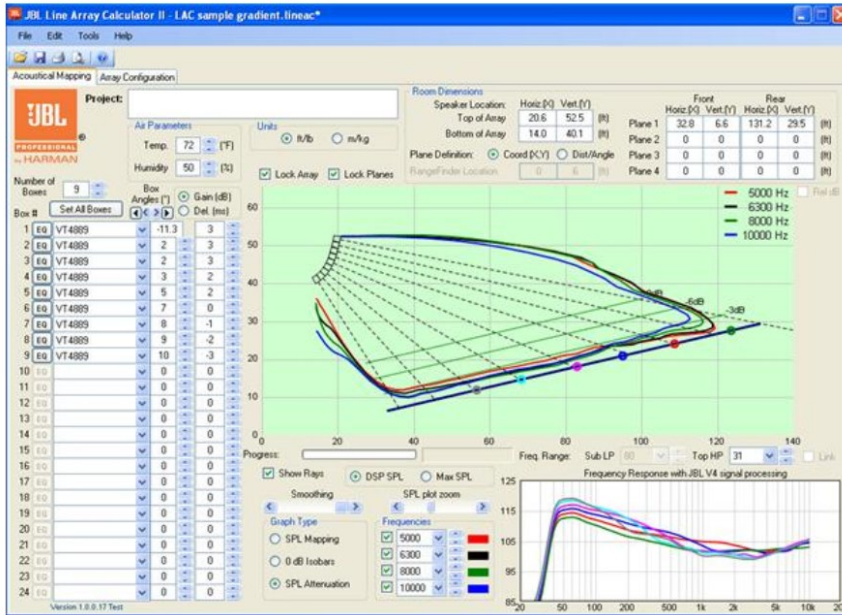

ADDING / ADJUSTING FREQUENCY RESPONSE PROBES

Right-clicking on a listening plane opens a context menu where it is possible to select “Show Freq Probe”. When this option is selected, a circular marker will appear and a frequency response curve displayed in the lower right window, corresponding to the probe at this location.

The SPL shown at the probe location is the calculated level due to the complex (magnitude and phase) summation of the array at each probe location. Subwoofer levels are scaled to provide summation at the recommended ratio of 2 subwoofers for every 3 “full-range” boxes.

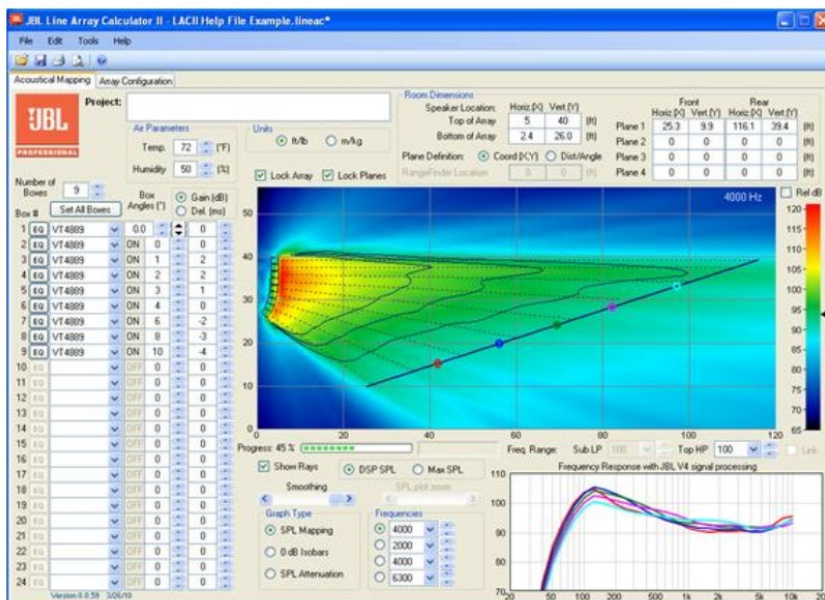

It is possible to “left-click” on a probe location and drag the probe along an audience plane to dynamically re-plot the frequency response in real time. Conceptually, this is the equivalent of walking along an audience listening plane with a measurement microphone.

“Right-click” on another open area of an audience plane to add additional frequency response probe locations (up to 6 total). Each probe can be dragged along the audience plane and positioned, as desired. Frequency response curves and probe locations can be deleted by right-clicking on the probe, and selecting “Remove Freq Probe” or “Remove All Freq Probe”.

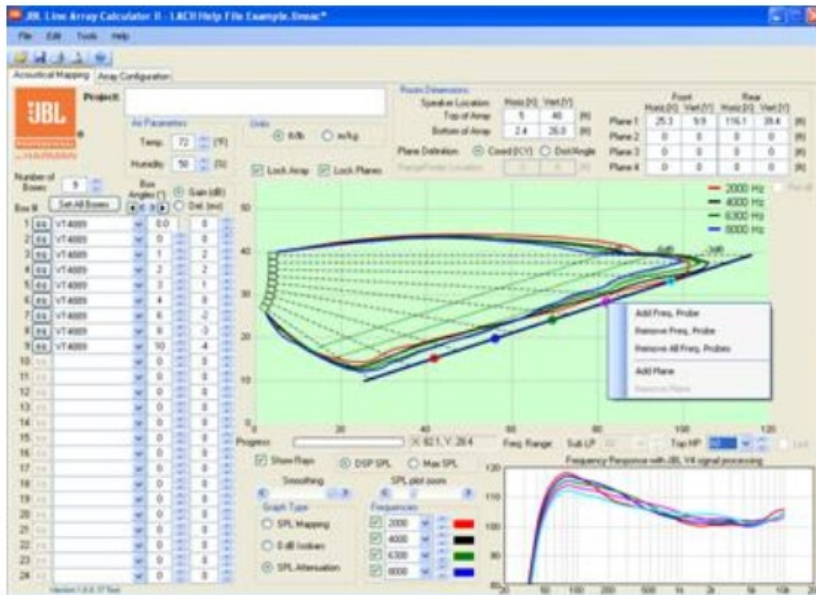

Note: To avoid accidentally moving planes or the speaker array, turn on the “Lock Array” and “Lock Planes” check boxes above the graphics window.

“Right-click” in the Frequency Response window and select “Show Marker” to display a cursor

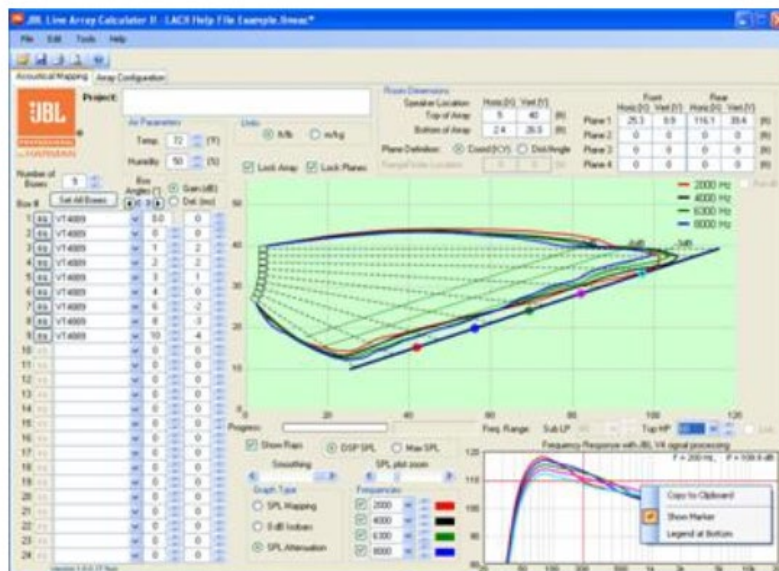

DOCUMENTING PROJECTS

Comments

Click on the Project: window in order to add comments and document your project. Comments entered on the Acoustical Mapping page are automatically copied to Array Configuration and Printout pages.

Project: VLA Compact Line Array Project#1A2B3C

Copying Graphs and Plots to the Clipboard

By “right-clicking” on “Frequency Response”, “SPL Mapping”, “0 dB Isobar” or “SPL Attenuation” windows, it is possible to copy any of these display views to the clipboard. From the clipboard, graphs can be pasted into any standard Windows application. The frequency response graph is in vector format and can be rescaled without loss of resolution. SPL Mappings, 0 dB Isobar or SPL Attenuation plots are captured as a 1:1 pixel bitmap.

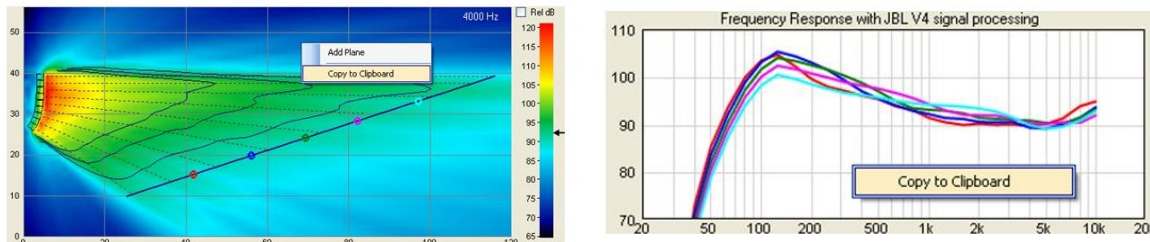

OPTIONS MENU

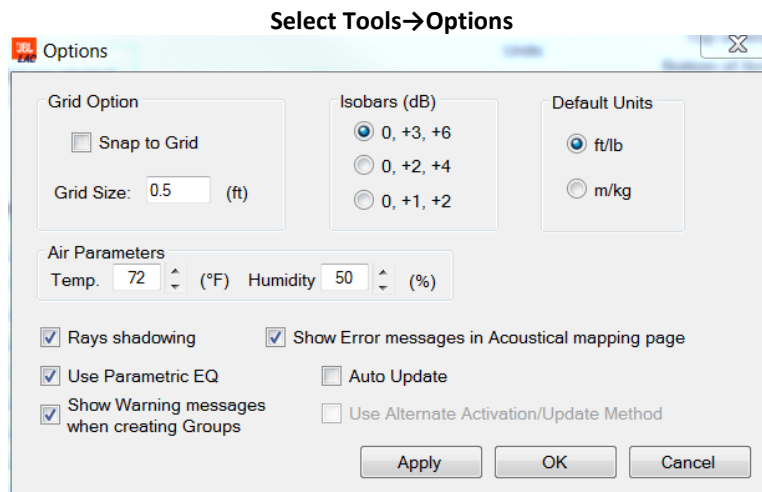

If **Snap to Grid** is selected, coordinates of features that are graphically modified in the mapping window, will automatically round to the nearest increment entered in “Grid Size”. Grid units (feet or meters) are

the same as the units selected in the main project window (on either Acoustical Mapping or Array Configuration tabs).

Isobars (dB) sets the spacing or range of the three SPL Isobars that are displayed when “SPL Mapping” is selected on the Acoustical Mapping tab.

Default Units sets the units default to either ft/lb or m/kg. Note that the units selected are saved as part of the project “.lineac” file. If a project is opened that was saved with different units than the preference specified in Tools/Options, the “.lineac” file will open showing the units that were selected by the user when the file was saved. It is always possible to change units using the radio buttons available on the Acoustical Mapping or the Array Configuration tabs. When units are changed, the program automatically converts from ft/lb to m/kg and temperature values are automatically converted from °F to °C, or vice versa.



When **Rays Shadowing** is selected, dotted reference lines showing the sight angle for each loudspeaker in the array stop when they first intersect a plane. If Ray Shadowing is not selected, then sight angle reference rays continue to the edge of the graphics plot.

Show Error Messages in Acoustical mapping page toggles warning messages on/off

Show Warning Messages when creating Groups toggles warning messages on/off

ARRAY CONFIGURATION TAB

The Array Configuration tab provides information that is useful for suspending the loudspeaker array. Any changes made to the array in the Array Configuration tab will automatically update in the Acoustical Mapping tab, and vice versa.

Exact suspension limits depend on enclosure type(s), array size, array shape, overall array orientation. Always refer to warning indications on the Array Configuration page.

Double-point suspension is recommended for minimized risk.

ANSI Standard E1.8-2005 (Entertainment Technology Loudspeaker Enclosures Intended for Overhead Suspension) Section 5.3.4 specifies a minimum 5:1 design factor.

Overhead suspension of loudspeaker systems should be undertaken only by trained and qualified personnel.

JBL Professional is not responsible for the use, misuse or misapplication of these products.

Design Factor

Design factors of 5:1, 7:1, or 10:1 can be selected. It is advised to check local regulations regarding design factor requirements.

Frame Options

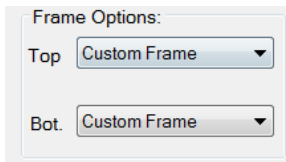

Frame Options:

Top Custom Frame ▼

Bot. Custom Frame ▼

The Frame Options cells allow selection of a number of suspension options. The selected frame will be utilized for the Suspension Detail limits. The **VLA-C-SB** is a light-duty suspension bar intended for use with very small (2 or 3 speaker) arrays, under a limited set of suspension angles. Selecting **Custom Frame** is the more common suspension method for larger arrays and will show vertical suspension lines which will need to be attached to a custom array frame or secure attachment points on the building structure. Selecting **No Frame** removes the vertical suspension lines and frame limitations will not be utilized in the Suspension Detail computations.



Important: For any suspension, all suspension lines must be vertical and attach to secure points that will ensure that the suspension lines remain vertical during the life of the installation. Do not angle any suspension lines. Custom array frames may need to be designed and installed by the integrator or installer to provide safe attachment points for these vertical suspension lines.

Setting of Inter-Enclosure Splay Angles

See the VLA Compact User's Guide for instructions and diagrams showing how to use the angle brackets for setting inter-enclosure splay angles.

VLA COMPACT USER'S GUIDE

For additional information about VLA Compact loudspeakers and systems, see the VLA Compact User's Guide (Document #1000344625).



Example system assembly diagrams from the User's Guide:

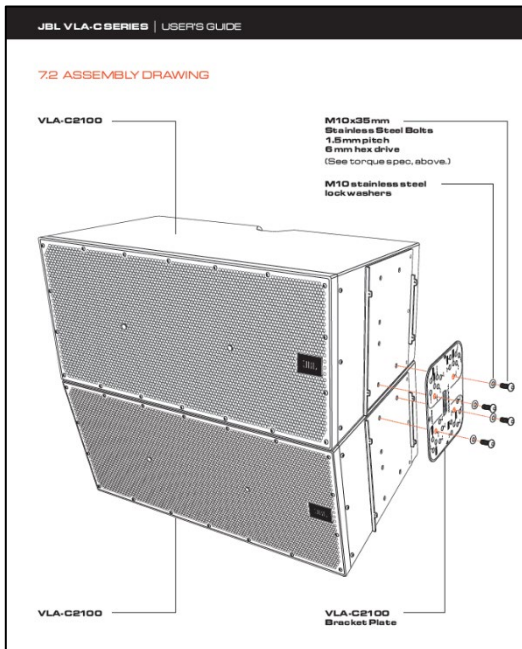

7.3 EXAMPLE OF 6-CABINET ARRAY

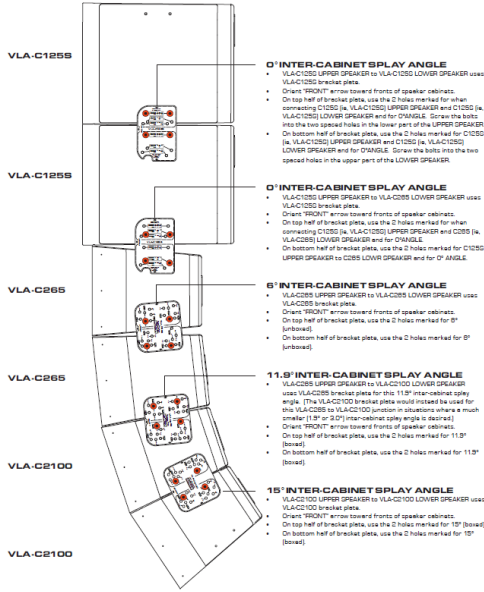

7.4 SIDE-PANEL EXTERNAL TRIM COVER PANELS

