

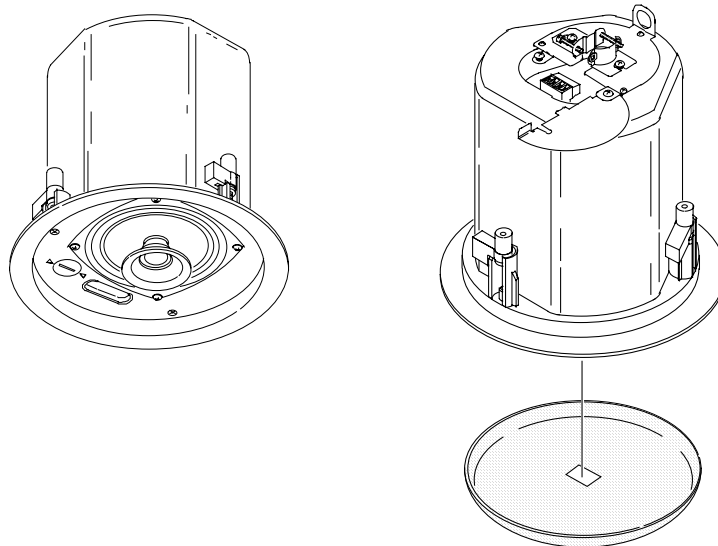

# Control Contractor Ceiling Loudspeakers

---

## Technical Application Guide



Rev A

Mar-99  
Rick Kamlet

# Table of Contents

---

|  |                  |
|--|------------------|
| Reference Charts from Owner’s Manual .....   | iv               |
| Optional Brackets, Cutout Sizes, Connector Hookup, Instructions & Descriptions   |                  |
| <b>JBL Distributed System Design (DSD) Software .....</b>  | <b>1</b>         |
| <b>Coverage .....</b>  | <b>1</b>         |
| Understanding Coverage .....   | 1                |
| Polar vs. Listening-Plane Coverage Specs, Polar to Listening-Plane Conversion, Conversion Chart  |                  |
| Control Contractor Coverage.....   | 4                |
| Coverage Angles, Broadband vs. Single Frequency Coverage Specs, Single Speaker Coverage  |                  |
| <b>Sound Pressure Level (SPL) .....</b>  | <b>5</b>         |
| Maximum Sound Level (SPL) Capability.....  | 5                |
| Max SPL Table.....   | 6                |
| SPL of 70V/100V vs. Low Impedance Speakers .....   | 7                |
| Power Compression.....   | 7                |
| <b>Speaker Layout and Spacing.....</b>   | <b>7</b>         |
| Layout Patterns – Square and Hexagonal Patterns .....  | 7                |
| Layout Density Factors – Edge-to-Edge, Minimum Overlap and Maximum Overlap.....  | 8                |
| Considerations for Selecting Layout Density, Additional SPL Due to Speaker Density, Level Variations<br>Due to Speaker Density, Audience Mobility Considerations, Room Characteristics, Rough<br>Guideline for Layout Density, Using Acoustic Modeling Computer Programs |                  |
| <b>Subwoofers .....</b>  | <b>12</b>        |
| Crossovers, Target SPL for Subs, Positioning, How Many C19CS Subwoofers to Use, Ratio<br>Table, Higher Output Subwoofer Options  |                  |
| <b>Technical Considerations.....</b>   | <b>14</b>        |
| Designing for Speech Intelligibility .....   | 14               |
| Setting SPL Target Goals .....   | 14               |
| Equalizing Ceiling Speakers.....   | 15               |
| Low Impedance vs. 70V/100V Speakers .....  | 16               |
| Connection (Hookup Diagrams).....  | 17               |
| Low-Impedance, 70V/100V, Hybrid Systems  |                  |
| Stereo Distributed Speakers.....   | 19               |
| <b>Additional Application Support .....</b>  | <b>back page</b> |

## Reference Charts from Owner's Manual

The following charts and diagrams from the Owner's Manual are included here for reference:

**Table 1:  
Optional New-Construction Brackets**

| Model                | New Construction Bracket | Plaster-Ring Bracket |
|----------------------|--------------------------|----------------------|
| Control 24C & 24CT   | MTC-24NC                 | MTC-24MR             |
| Control 26C & 26CT   | MTC-26NC                 | MTC-26MR             |
| Control 19CS & 19CST | MTC-19NC                 | MTC-19MR             |

**Table 2:  
Cutout Sizes**

| Model                | Cutout Size (diameter) |
|----------------------|------------------------|
| Control 24C & 24CT   | 168 mm (6.6 in)        |
| Control 26C & 26CT   | 220 mm (8.75 in)       |
| Control 19CS & 19CST | 305 mm (12.0 in)       |

### Connector Hookup

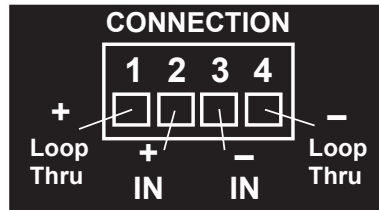

## Installation Instructions & Model Descriptions

Complete step-by-step installation instructions and model descriptions are available in the Ceiling Speaker Owner's Manual, CEILING SPKR MANUAL, included with each set of speakers.

This Technical Application Guide is intended as an adjunct to the Owner's Manual that comes with the JBL Control Contractor ceiling speaker. The intent is to assist sound system designers – from the new designer to the experienced systems contractor – to design superior distributed system installations utilizing JBL Control Contractor Ceiling Speakers.

## **JBL Distributed System Design (DSD™) Software**

JBL DISTRIBUTED SYSTEM DESIGN is a software utility from JBL Professional that calculates and displays speaker spacing and positioning of Control Contractor ceiling speakers within a rectangular room. Several acoustical calculations are also made and the resulting document can be saved and printed. The computations are based on actual measurements of these loudspeakers, yielding results that closely reflect actual performance of these loudspeakers within the listening space.

Many of the calculations contained in this application guide are provided in the DSD software. It is a convenient way to make many of these design considerations and simulate what the performance will be for various possible design iterations.

The program can be downloaded from the JBLPRO.COM website or obtained from JBL Professional on diskette.

## **Coverage**

The goal in placing loudspeakers in a distributed system is to cover the area effectively, where the sound is audible and intelligible over the entire area, and where the system is capable of sustaining the required sound pressure level for the application type.

### **Understanding Coverage**

The JBL Control Contractor Ceiling Speakers are designed to provide extremely even coverage on a broadband basis over a wide coverage area. A misunderstanding of the coverage angle specifications can easily result in mistakes being made in system designs. The COVERAGE ANGLE is defined as the included angle at which the sound level is 6 dB down from the on-axis sound level. The coverage angle on the listening plane is an important figure for the coverage density computations used later in this guide.

**Polar vs. Listening-Plane Coverage Specifications:** There are two different types of coverage measurements which are often confused with each other. It is standard in the loudspeaker industry to state the coverage in a “polar” pattern – in other words, in a sphere that is 1 meter from the microphone in all directions. The angle within which the sound levels is within 6 dB of the on-axis level is called the POLAR coverage pattern. This is a legitimate specification, but does NOT represent what the coverage will be over a flat listening plane, such as in a room. For speakers projecting from a ceiling onto flat listening plane, the sound has to travel farther off-axis (to the sides) than it travels on-axis (directly below the speaker) resulting in a much greater drop-off of sound level off-axis. The end result is that the actual coverage angle on the listening plane is more narrow than what is claimed. Some ceiling speaker manufacturers use their POLAR measurement to claim extraordinarily wide coverage. DO NOT use this specification to lay out coverage patterns of ceiling speakers!!!

The sound system designer needs to work with the coverage over a flat listening plane – this is called the LISTENING-PLANE coverage specification. The LISTENING-PLANE spec represents the REALITY of the speaker's coverage for the listeners. Laws of physics dictate that the listening-plane coverage is always more narrow than the polar coverage pattern.

By looking at the example of a speaker that has a 140 degree POLAR coverage, we can see that it would be a mistake to assume that this speaker can cover 140 degrees over the listening plane. In fact, the level at the edges of a 140 degree pattern is actually more than 15 dB down compared to on-axis, NOT 6 dB. While the actual LISTENING-PLANE coverage depends on the exact characteristics of the polar plot, the coverage of the listening plane from a speaker with a 140 degree POLAR coverage is usually between 90 and 110 degrees.

### Coverage of Speaker with 140° POLAR Spec

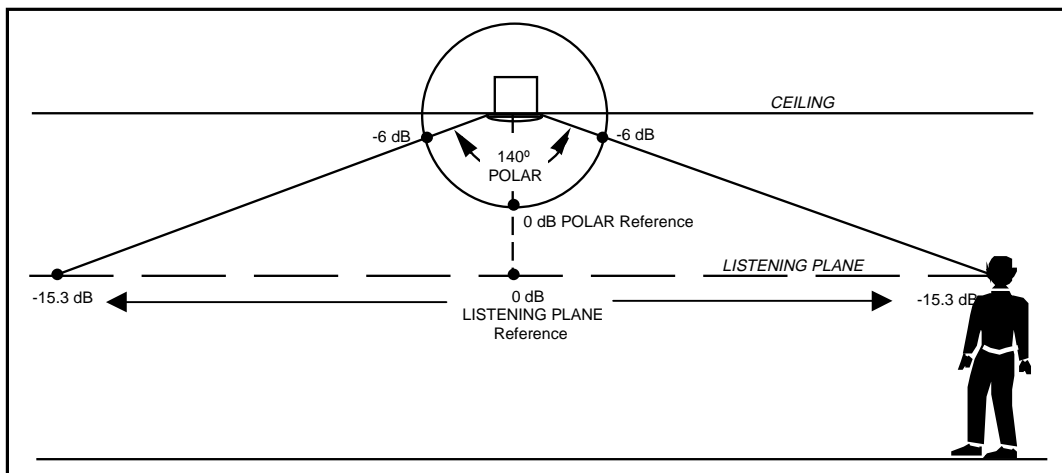

### Actual LISTENING PLANE Coverage of Speaker with 140° POLAR Spec

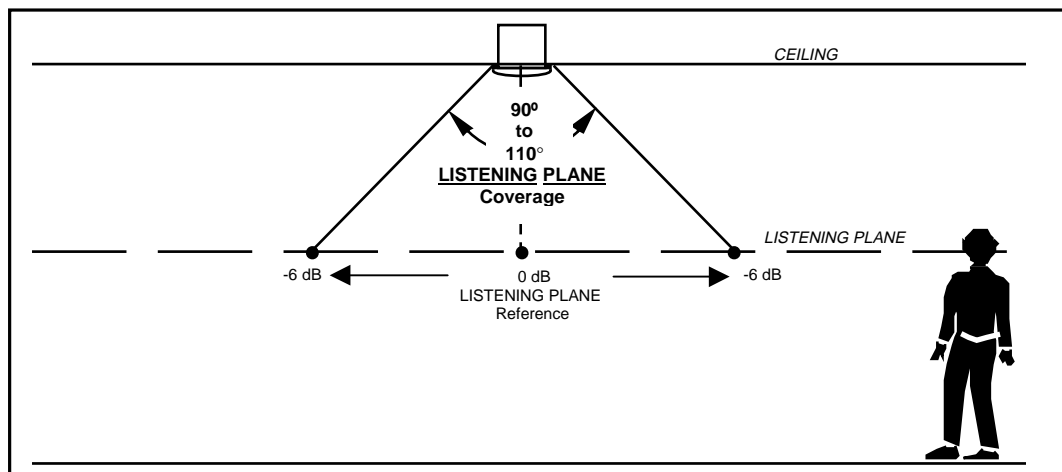

### Polar-to-Listening-Plane Conversion –

To compute the LISTENING-PLANE coverage more precisely, you need to use the exact polar plot of the speaker (real polar plots directly from test equipment are better than an artist's redrawing). Polar plots are usually normalized to the on-axis value, which is usually labeled "0 dB". For every angle off-axis, there is a difference-figure between this normalized 0 value and the actual level. To convert to LISTENING-PLANE coverage, add the "ΔdB" figure from the following chart for that angle off-axis to the difference figure from the polar plot (be sure the difference-figure is a negative number).

**Table 3:**  
**POLAR-TO-LISTENING-PLANE**  
**COVERAGE CONVERSION CHART**

| Angle Off-Axis | ΔdB Correction Factor | Angle Off-Axis | ΔdB Correction Factor |
|----------------|-----------------------|----------------|-----------------------|
| 5°             | -0.0 dB               | 45°            | -3.0 dB               |
| 10°            | -0.1 dB               | 50°            | -3.8 dB               |
| 15°            | -0.3 dB               | 55°            | -4.8 dB               |
| 20°            | -0.5 dB               | 60°            | -6.0 dB               |
| 25°            | -0.9 dB               | 65°            | -7.5 dB               |
| 30°            | -1.3 dB               | 70°            | -9.3 dB               |
| 35°            | -1.7 dB               | 75°            | -11.7 dB              |
| 40°            | -2.3 dB               | 80°            | -15.2 dB              |

By using the actual polar plot of the speaker and applying these correction factors from the chart, the angle which results in a figure of -6 dB is the REAL 6 dB down angle on the listening plane. The new coverage angle is valid regardless of the ceiling height.

**Example --** If we look at the polar plot of a hypothetical speaker with 140° coverage, we see that at 70° off-axis (140° total for both sides) the level is down 6 dB compared to the on-axis level. By looking at the Polar to Listening Plane Conversion Chart, we need to add -9.3 dB to this -6 dB figure to find the actual level on the listening plane at this off-axis angle. We find that the level of this 140 degree speaker (as specified by the POLAR coverage), is actually -15.3 dB (it is NOT -6 dB) down at 70° off-axis. Therefore, listeners located at this off-axis angle will hear sound that is more than 15 dB down from the level they hear when they pass directly underneath (on-axis) the speaker. This is a very large difference.

To find the actual 6 dB down point of the speaker for the listening plane, take the actual polar plot of the speaker and at every increment of 5 degrees off-axis, apply the correction factors from the polar-to-isobar conversion chart. The 6 dB down angle is that angle at which the figure is -6 dB (POLAR dB down PLUS correction factor). While it depends on the actual polar plot of the speaker, speakers with a nominal POLAR coverage of 140° can be expected to reach -6 dB between 45° and 55° off-axis, resulting in an actual LISTENING PLANE coverage of between 90° and 110°.

**Control Contractor Ceiling Speaker Coverage:** Following are both the polar and isobar coverage angles for the Control Contractor Ceiling Speakers:

**Table 4  
CONTROL CONTRACTOR  
COVERAGE ANGLES**

| Model                | Nominal Coverage (POLAR)            | Nominal Coverage (LISTENING PLANE) |
|----------------------|-------------------------------------|------------------------------------|
| Control 24C & 24CT   | 130° conical                        | 100° conical                       |
| Control 26C & 26CT   | 110° conical                        | 95° conical                        |
| Control 19CS & 19CST | Omnidirectional (180°) below 160Hz. | 120° conical                       |

**Broadband vs. Single-Frequency Coverage Specifications:** Some ceiling speakers specify their coverage only at a particular frequency, -- for example, at 2 kHz -- but the coverage at other frequencies (1 kHz, 4 kHz, 8 kHz, etc) can be vastly narrower at higher frequencies and broader at lower frequencies. These types of speakers do not provide even coverage throughout the audio spectrum. Every spot within the listening area ends up with a different frequency responses and different sound levels. By contrast, Control Contractor models maintain their specified coverage angles throughout most of the audio spectrum, resulting in a more consistent tonal character throughout the listening area and less variation in sound levels.

**Variation in Polar Coverage  
of Typical 200 mm (8 in) Cone Driver  
(Theoretical Coverage by Frequency)**

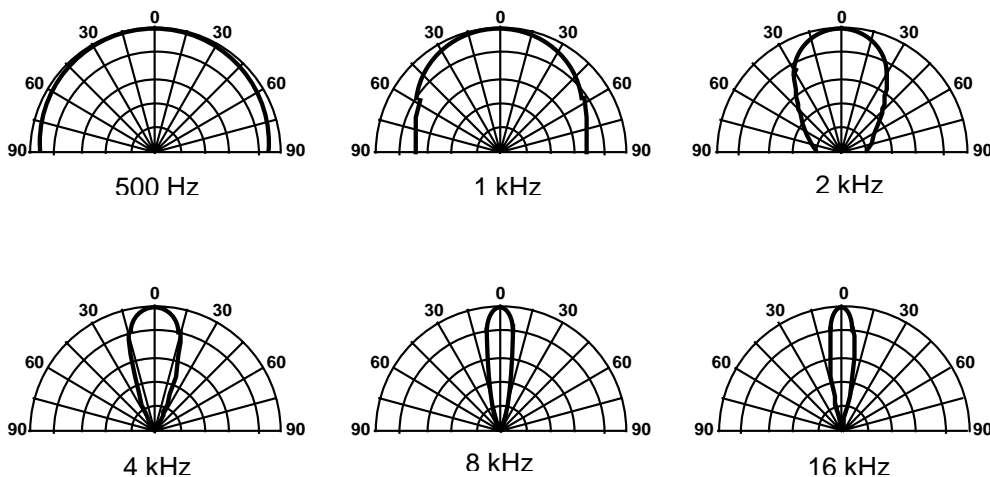

*Based on 165 mm (6.5 in) radiating diameter*

## Polar Coverage of Control 26C *(Actual Coverage by Frequency)*

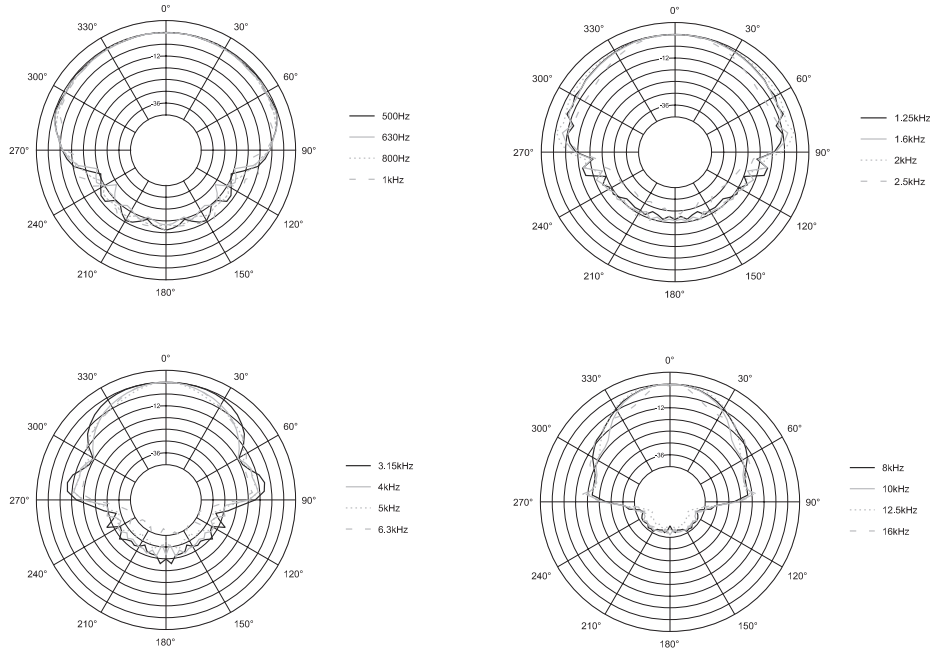

**Single Speaker Coverage** – The coverage area of a single speaker depends on the distance of the speaker from the listener, which depends upon the ceiling height and the listening height (seated vs. standing). The following chart assumes a 4 ft (1.2 m) listening plane and averages coverage over the 500 Hz to 8 kHz range:

**Table 5:**  
**SINGLE SPEAKER COVERAGE**  
Diameter of Circular Coverage Pattern, Listening Plane

|   | Control 24C/24CT | Control 26C/26CT |
|---|------------------|------------------|
| 10 Ft (3.1 m) Ceiling Height:<br>-6 dB coverage | 14 ft ( 4.3 m)   | 13 ft ( 4.0 m)   |
| 14 Ft (4.3 m) Ceiling Height:<br>-6 dB coverage | 23 ft ( 7.0 m)   | 21 ft ( 6.4 m)   |

## Sound Pressure Level (SPL)

**Maximum Sound Level (SPL) Capability** – In the simplest theoretical terms, loudspeakers are capable of producing sound levels as determined by their sensitivity (the sound level they produce with one watt of power) and their power handling capability (driven with an industry-standard pink noise signal) and the distance the listening plane is from the speakers. This is NOT, however, a measure of the typical MUSIC or SPEECH that can be expected from the system. Pink noise is different from music and speech. A



downward adjustment of at least 4 dB must be made to the maximum pink noise computation to reflect the maximum average SPL capability for music or speech.

To compute the “Maximum SPL (Sound Pressure Level) of Music or Speech” of a single loudspeaker use the following formula:

$$\text{MAX AVERAGE SPL (for MUSIC AND SPEECH)} = 10 (\log (\text{PINK NOISE POWER HANDLING})) + \text{SENSITIVITY} - 4 - 20(\log(\text{DISTANCE IN METERS}))$$

The answer is in decibels (dB)

For those who want to know more about this formula, this is how it is derived:

- MAXIMUM AVERAGE SPL (at 1 meter distance)** is computed by taking 10 times the log of the **PINK NOISE POWER HANDLING** (the “power capability” specification) and then adding the **SENSITIVITY** specification.
- By definition, the computation for **MAXIMUM PEAK SPL (at 1 meter distance)** for pink noise is the **MAXIMUM AVERAGE SPL (at 1 meter distance)** plus 6 dB.
- We have found that typical music and speech signals used for business music have a peak-to-average ratio around 10 dB. Therefore, the **MAXIMUM AVERAGE MUSIC AND SPEECH SPL (at 1 meter distance)** is 10 dB lower than the **MAXIMUM PEAK SPL (at 1 meter distance)**.
- To determine the **MAXIMUM AVERAGE MUSIC AND SPEECH SPL** at a certain distance from the speaker, take the log of the **DISTANCE** from the speaker (in meters) and multiply that by 20. Subtract the resulting figure from the **MAXIMUM AVERAGE MUSIC AND SPEECH SPL figure for 1 meter**.
- Therefore, the final equation is: **MAXIMUM AVERAGE SPL FOR MUSIC AND SPEECH** is 10 times the log of the **POWER HANDLING** spec plus the **SENSITIVITY** spec minus 4 dB minus 20 times the log of the **DISTANCE** from the speaker (in meters).

**Max SPL Table --** The following table shows the maximum continuous and peak SPL capabilities of the Control Contractor models on-axis with the loudspeaker at a 4 ft (1.2 m) listening plane for a SINGLE loudspeaker with NO overlapping coverage from adjacent loudspeakers:

The SPL capability in MULTIPLE speaker systems is HIGHER than what is indicated in this table by as much as +6 dB, depending on layout pattern and density. See Table 7 in the Speaker Layout and Spacing section below for the additional SPL capability from MULTIPLE speaker systems.

**Table 6:  
CONTROL CONTRACTOR  
SINGLE SPEAKER SPL CAPABILITY  
(On-Axis)**

|                              | Control<br>24C    24CT <sup>1</sup> |        | Control<br>26C    26CT <sup>2</sup> |        | Control<br>19CS <sup>3</sup> 19CST <sup>3</sup> |        |
|------------------------------|-------------------------------------|--------|-------------------------------------|--------|---|--------|
| <b>10 Ft (3.1 m) Ceiling</b> |                                     |        |                                     |        |   |        |
| Avg Music & Speech           | 92 dB                               | 90 dB  | 98 dB                               | 96 dB  | 103 dB  | 101 dB |
| Avg Pink Noise               | 96 dB                               | 94 dB  | 102 dB                              | 100 dB | 107 dB  | 105 dB |
| Peak                         | 102 dB                              | 100 dB | 108 dB                              | 106 dB | 113 dB  | 111 dB |
| <b>14 Ft (4.3 m) Ceiling</b> |                                     |        |                                     |        |   |        |
| Avg Music & Speech           | 88 dB                               | 86 dB  | 94 dB                               | 92 dB  | 99 dB   | 97 dB  |
| Avg Pink Noise               | 92 dB                               | 90 dB  | 98 dB                               | 96 dB  | 103 dB  | 101 dB |
| Peak                         | 98 dB                               | 96 dB  | 104 dB                              | 102 dB | 109 dB  | 107 dB |

Note: This chart assumes adequate amplification and does not take power compression into consideration.

<sup>1</sup> Control 24CT at 30 W tap, takes the transformer insertion loss into consideration.

<sup>2</sup> Control 26CT at 60 W tap, takes the transformer insertion loss into consideration.

<sup>3</sup> Control 19CS & 19CST figures are for installation within 3 feet of a corner. For speaker installation near one wall, reduce the figures by 3 dB. For speaker installation in the center of the ceiling, reduce the figures by 6 dB.

**SPL of 70V/100V vs. Low Impedance Speakers** – 70V/100V speakers produce lower maximum output due to a number of factors. First, they are tapped at lower power levels than the low-impedance speaker’s capabilities. Second, there is always some “insertion loss” through the speaker transformer. In addition, speakers operated from a 70V or 100V line will produce substantially lower overall SPL capabilities if the driving amplifier clips short-term peaks immediately at 70V or 100V and if it doesn’t have much dynamic (short-term) headroom. Amplifiers with higher clipping limits and greater dynamic headroom can result in substantially higher output from 70V/100V loudspeakers.

Note: All of the computations in Table 6 assume JBL MPC amplifiers which exhibit high clipping limits AND good dynamic headroom.

**Power Compression** -- One must also take into consideration the fact that speakers compress the sound at high levels (as their voicecoil temperatures rise, causing the impedance to go up, resulting in less draw of audio power from the same voltage drive signal). This is called “power compression”. We have left power compression out of the formulas because speakers differ in their power compression, and because the degree of compression is highly dependent on operational factors such as the peak-to-average ratio of the signal source. A general guideline is to assume around 2 or 3 dB of compression for good quality speakers (such as those with large diameter voicecoils) with typical music or speech and to assume as much as 5 or 6 dB of compression with inexpensive speakers (especially those with small diameter voicecoils and/or low power ratings) operating with compressed music sources.

## Speaker Layout and Spacing

There are a number of different patterns that can be used for laying out ceiling speakers, and each pattern can be implemented with various density factors. The pattern and density selected for an installation affect the:

- Evenness of coverage
- Sound level capability
- Intelligibility
- Cost of the system
- Power amplification requirements

**Layout Patterns** – Although there may be many ways to lay out the speakers in a distributed system, two basic patterns that have gained wide acceptance are SQUARE and HEXAGONAL. The choice of a square or hexagonal layout is usually a function of the room dimensions and shape.

Square Layout Pattern

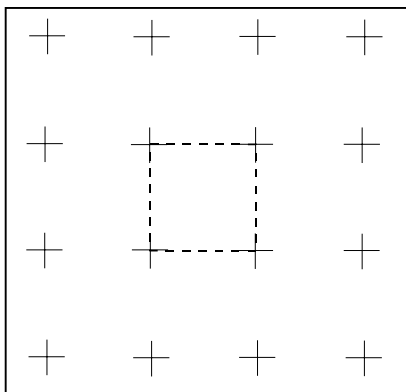

Hexagonal Layout Pattern

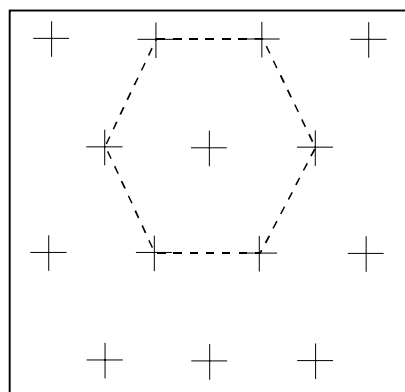

**Square Pattern** – The square pattern often requires fewer speakers, resulting in a lower system cost. A square pattern sometimes may be easier to lay out on a suspended ceiling tile grid. It may also be easier to zone large open spaces using the square pattern. The square pattern is usually a good starting point for a design.

**Hexagonal Pattern** – A hexagonal layout pattern may require fewer speakers in rooms where only part of a speaker’s coverage is required in the square layout at the end of each row, such as where the end speaker is covering only a small area. In such cases, the number of speakers in each row can sometimes be reduced by one and the rows offset from each other, with the offset speaker from the next row partially filling in for the uncovered area from the adjacent row. For example, in an edge-to-edge density, there can be an advantage using a hexagonal layout in rooms with widths or depths that would require about 1/2 of the speaker’s coverage diameter. By offsetting each row of speakers, the end speaker in each row can fill in for the lack of speaker at the end of the adjacent rows. In addition, some rooms with offsets or odd-shaped rooms sometimes might work better with a HEXAGONAL pattern.

**Layout Density Factors** – The three most common Density Factors of each layout are: Edge-to-Edge, Minimum Overlap, and Maximum Overlap.

Edge-to-edge density places the speakers such that the outside edges of their single-speaker 6 dB down points just touch each other. Minimum Overlap is a tighter spacing where there are no spots that are not within the 6 dB coverage pattern of one of the speakers. Maximum overlap is tighter still, such that the 6 dB down point of one speaker extends to the on-axis point of adjacent speakers, and where most listeners are within the coverage pattern of at least two speakers. Each of these patterns is diagrammed below.

**Square Patterns**

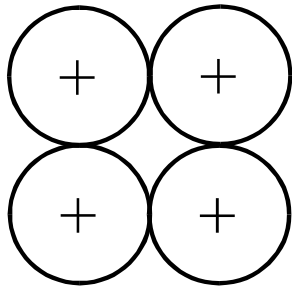

a) Edge-to-Edge

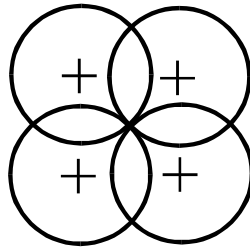

b) Minimum Overlap

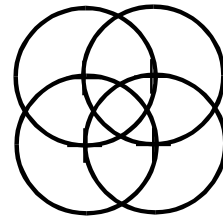

c) Full Overlap

**Hexagonal Patterns**

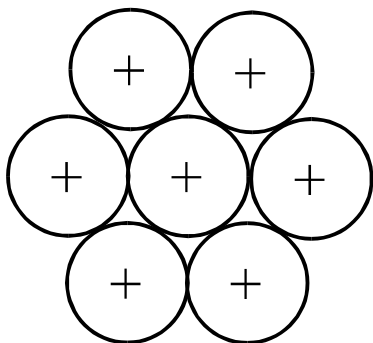

a) Edge-to-Edge

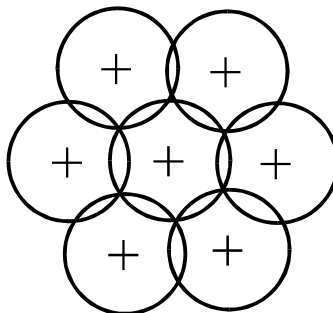

b) Minimum Overlap

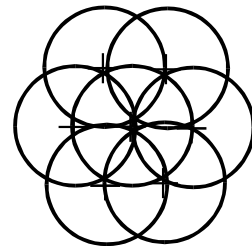

c) Full Overlap

**Considerations for Selecting Layout Density** -- Higher speaker density (tighter spacing) provides higher SPL capability, overcomes ambient noise better and reduces the differences in sound level from location to location within the space. Lower densities result in fewer speakers and lower system cost, but provide lower SPL capability and greater variations in level within the space. In a fairly dead room, with low ambient noise, little or no paging/voice reinforcement, and an SPL requirement within the capability of a non-overlapped loudspeaker, then an edge-to-edge pattern will often suffice. By contrast, in a room with a lot of reflective surfaces, high ambient noise and a paging or sound reinforcement requirement, then a minimum overlap or full overlap is probably indicated. Full overlap should be used for the most critical high quality sound reinforcement systems.

Budget, of course, may force acceptance of an edge-to-edge or wider spacing when a higher density would be desirable. In this case, the designer should make the client aware of the potential ramifications of this choice before the system is installed.

**Additional Sound Level (SPL) Due to Speaker Density** – Tighter layout densities allow for higher SPL level due to a greater number of speakers covering each area within the listening space. In some cases, substantial increases in SPL can be achieved from high densities. The following chart provides the SPL ADDITION within the listening space.

**Table 7:  
Additional SPL Due to Layout Pattern & Density**

| Layout Pattern and Density | ADDITIONAL SPL Due to Pattern & Density |
|----------------------------|---|
| <b>SQUARE PATTERN</b>      |   |
| Maximum Overlap            | +5.2 dB                                 |
| Minimum Overlap            | +2.0 dB                                 |
| Edge-to-Edge               | +0.7 dB                                 |
| 1.4 x Edge-to-Edge         | +0.4 dB                                 |
| 2 x Edge-to-Edge           | +0.2 dB                                 |
| <b>HEXAGONAL PATTERN</b>   |   |
| Maximum Overlap            | +5.4 dB                                 |
| Minimum Overlap            | +1.4 dB                                 |
| Edge-to-Edge               | +1.0 dB                                 |
| 1.4 x Edge-to-Edge         | +0.5 dB                                 |
| 2 x Edge-to-Edge           | +0.3 dB                                 |

**Level Variation Differences Due to Layout Density** – The speaker density affects the amount of variation of the sound level within the listening space. The tighter the spacing, the more consistent the sound will be from place to place within the space. The chart below provides a list of the level variation for each layout pattern and density. While on-axis levels will correspond with the on-axis SPL computations, the SPL at some off-axis locations will be LOWER by as much as the stated figure.

For example, in a square pattern installation with edge-to-edge density, if the on-axis Maximum SPL for Music and Speech (considering distance from the speaker and any additional SPL from layout density) is computed to be 92 dB, from looking at the chart we can see that there will be some locations within the listening space that will be 4.4 dB lower in level, or 87.6 dB.

It is important to consider level variation in distributed systems design, and not assume that every location within a listening space will be at the same level – or can achieve the same maximum SPL – as does a location directly under a speaker.

**Table 8:**  
**Level Variation Due to Layout Pattern & Density**

| Layout Pattern and Density | Level Variation within the Listening Space |
|----------------------------|--|
| <b>SQUARE PATTERN</b>      |  |
| Maximum Overlap            | -1.4 dB                                    |
| Minimum Overlap            | -2.0 dB                                    |
| Edge-to-Edge               | -4.4 dB                                    |
| 1.4 x Edge-to-Edge         | -6.8 dB                                    |
| 2 x Edge-to-Edge           | -10.4 dB                                   |
| <b>HEXAGONAL PATTERN</b>   |  |
| Maximum Overlap            | -1.2 dB                                    |
| Minimum Overlap            | -2.6 dB                                    |
| Edge-to-Edge               | -5.4 dB                                    |
| 1.4 x Edge-to-Edge         | -10.2 dB                                   |
| 2 x Edge-to-Edge           | -17.3 dB                                   |

**Audience Mobility Considerations** – Seated audiences, such as in a restaurant, can be bothered by excessive level variation throughout the space because one table can be disturbed by a high sound level at the same time that another table can't hear the music or paging adequately. In some applications where the audience is walking around, such as in a retail or grocery store, there may be slightly more of an expectation of variations in coverage.

**Room Characteristics** -- In any choice of coverage pattern, room obstacles, microphone locations, seating areas and any requirements for quieter areas should be considered.

**Rough Guideline for Layout Density** -- The following rough guidelines are for seated venues. Denser spacing, where it is economical to accomplish, will usually result in better performance than wider spacing:

Low-Level Background Music Only – Wider spacings, such as edge-to-edge spacing is usually acceptable.

Background Music with Basic Paging – Spacing of edge-to-edge or tighter is usually acceptable for basic paging.

Music with High Quality Paging – Minimum overlap spacing is often required for clear, even intelligibility.

Heavy Speech Reinforcement – In spaces that are used heavily for speech reinforcement, such as meeting rooms, it is important to space the speakers closely enough to provide as even coverage as possible. Minimum overlap spacing or full overlap spacing is recommended for these applications.

**Table 9: Rough Guideline for Layout Density**

|   | Edge-to-Edge | Minimum Overlap | Full Overlap |
|---|--------------|-----------------|--------------|
| Low Level Background Music                | ✓            | ✓               | ✓            |
| Background Music with Basic Paging        | Maybe        | ✓               | ✓            |
| Foreground Music with High Quality Paging | ✗            | Maybe           | ✓            |
| Heavy Speech Reinforcement                | ✗            | Maybe           | ✓            |

In summary, the choice of speaker model, layout patterns and layout density should be made on the basis of many factors, including:

- Acoustics of the room
- Ambient noise
- Sound level requirement
- Required intelligibility of voice paging
- Evenness of coverage desired
- Type of music
- The importance of the sound within the space
- Type of listeners & listener expectations

**Using Acoustic Modeling Computer Programs** – For basic use, JBL’s Distributed Speaker Design software (DSD) computes speaker spacing, maximum continuous average SPL for pink noise, maximum continuous peak SPL, maximum continuous average SPL for music & speech, expected level variation of the direct sound and recommended amplifier power for speakers placed in a rectangular room.

CADP2 or EASE acoustic modeling computer programs are very accurate at predicting the performance of proposed sound system designs precisely for complex rooms. These programs allow the system designer to enter the exact parameters of the room (such as dimensions, surface materials, obstructions, architecture), and simulate the performance, coverage, and intelligibility resulting from various loudspeaker selection and placement options. Device files for the Control Contractor ceiling loudspeakers are available in the U.S. directly from JBL Professional. In areas outside the U.S. device files can be obtained from JBL’s authorized Distributor in your region. Device files can also be downloaded from the JBL Professional web site at [www.jblpro.com](http://www.jblpro.com).

## **Subwoofers**

Subwoofers can be a very important part of making a business music system outstanding. The Control 19CS and 19CST in-ceiling subwoofers provide good bass from an extremely compact enclosure that can be installed into a ceiling.

The number of subwoofers to use, where to position them, how to set the taps (on 70V/100V units) and how loud to run them can vary depending on the characteristics of the individual situation, such as placement, boundary loading, size of the room, coupling of multiple speakers/subwoofers, type of music, type of activity, and the expectations of the listeners. The following guidelines are therefore in very general terms.

### **Crossovers**

The Control 19CS exhibits a gentle, natural low-pass roll-off. It can be connected in parallel with Control 24's or Control 26's in most applications. This results in a balanced sound. However, the overall performance of a system can be further improved by actively crossing the system over between the full-range speakers and the subwoofers, instead of overlapping them.

**Using an Active Crossover** – A better overall sound can be attained by using an active crossover and a separate amplifier channel for the subwoofers. When subwoofers and full-range speakers are operated in parallel (from the same full-range signal), a frequency response bump in the band where both speakers produce sound (between 80 Hz and 160 Hz) can result. This gives the impression of strong mid-bass or high-bass, which is often acceptable or desirable, but it may lessen the impression of low-bass (subwoofer). Using an active crossover, set between 80 Hz and 120 Hz -- 4<sup>th</sup> Order (24 dB per octave) is recommended -- results in very flat frequency response down to 45 Hz, giving strong low-bass and a higher fidelity sound.

Stand-alone outboard electronic crossovers are available, but can be expensive. Inexpensive crossover modules are available for the JBL MPC power amplifiers, providing active crossing-over at an affordable price. MTC-X100 is a preset at 100 Hz (24 dB/oct) and the MTC-XU is a universal crossover module with a wide selection of crossover frequencies. These modules solder onto the existing input cards of the JBL MPC power amplifiers.

**Target SPL for the Subwoofers** – Typically, the goal for subwoofers is for them to be somewhere between the same loudness and 10 dB louder than the mid-high/full-range speakers in the system. Low level music tends to require subs to be louder compared to the mid-high/full-range speakers, because at low sound levels the human ear needs more bass for a perception of well balanced sound. Given the same music, higher levels of music can sound well balanced with less RELATIVE bass. There is also some music types and applications, like dance music in upscale fashion retailers, that require more subwoofers. Setting the ratio of subs to mid-high/full-range speakers somewhere between 0 dB and +10 dB is usually a good starting point.

**Positioning of the Subwoofers** – Placing a C19CS subwoofer within 3 feet of a wall increases its output by 3 dB. Placement within 3 feet of a corner increases its output yet another 3 dB (or 6 dB total, as compared with being located away from a wall or ceiling). In these cases, there is both an increase in sensitivity (output per watt of input) and in maximum total SPL capability.

**How Many C19CS Subwoofers to Use** – Light background or foreground music usually does not require subwoofers. The Control 24C and Control 26C produce adequate bass levels to be able to turn the bass up (via tone control or EQ) and get good full-range sound for low-level music reproduction.

The following ratios are no more than rough guidelines intended as starting points. The system designer needs to compute the SPL capability and determine that it will meet the user-expectations for the application. (Note: The following assumes that the speakers are all installed in the ceiling away from wall and corner boundary surfaces (not getting the bass reinforcement from these boundary surfaces) and that 70V/100V models are tapped at their highest tap settings.)

**a) Overlap Mode -- Operating Control 24C/Control 26C Full-Range**

The Control 19CS subwoofer and the Control 24C or Control 26C full-range speakers can all be driven from a full-range signal. The bass capabilities of the full-range speakers add to that of the subwoofer.

**Medium Bass --** For music requiring medium bass reinforcement, a good starting point is to use one (1) Control 19CS subwoofer for every four (4) Control 24C full-range speakers. Because of the Control 24C's lower sensitivity (compared to the subwoofer), you will get substantial bass augmentation from a single subwoofer. A good starting point for Control 26's is to use one (1) Control 19CS subwoofer for every two (2) to four (4) Control 26C full-range speakers.

**Heavy Bass --** For music requiring heavy bass reinforcement, consider using one (1) Control 19CS subwoofer for every two (2) Control 24C full-range speakers and one (1) Control 19CS subwoofer for every one (1) to two (2) Control 26C full-range speakers.

**b) Active Crossover Mode -- Operating Control 24C/Control 26C High-Passed**

A better overall sound can often be attained with the ceiling speakers high-passed via a separate electronic crossover, resulting in deeper bass by eliminating the overlap (frequency bump) in the mid-bass region. In this configuration, the Control 19CS subwoofer takes a greater share of the low-frequency burden, so more subwoofers may be required:

**Medium Bass --** Start with one (1) Control 19CS subwoofer for every two (2) Control 24C high-passed speakers and one (1) Control 19CS subwoofer for every one (1) to two (2) Control 26C high-passed speakers.

**Heavy Bass --** Start with using one (1) Control 19CS subwoofer for every one (1) to two (2) C24C high-passed speakers and one (1) Control 19CS subwoofer for every one (1) Control 26C high-passed speakers or two (2) subwoofers for every one (1) Control 26C.

**Table 10:  
Ratio of C19 Subs to Mid-High/Full-Range Speakers  
(Rough Starting Points)**

|                              | Ratio of<br>C19CS : C24C | Ratio of<br>C19CS : C26C |
|------------------------------|--------------------------|--------------------------|
| <b>OVERLAP MODE</b>          |                          |                          |
| Medium Bass                  | 1:4                      | 1:4 or 1:2               |
| Heavy Bass                   | 1:2                      | 1:2 or 1:1               |
| <b>ACTIVE CROSSOVER MODE</b> |                          |                          |
| Medium Bass                  | 1:2                      | 1:2 or 1:1               |
| Heavy Bass                   | 1:1 or 1:2               | 1:1 or 2:1               |

(See text for positioning, powering and tap-setting assumptions behind these ratios.)

**Higher Output Subwoofer Options --** Even though the Control 19 delivers amazing bass output for its size, it may not be the correct selection for applications that require very high subwoofer output. JBL Professional manufactures a wide selection of high powered subwoofers, including both passive and self-powered models as well as units that can be affixed to the wall or suspended from the ceiling.



# **Technical Considerations**

## **Designing for Speech Intelligibility**

- **Choose the Appropriate Speaker for the Application**

**Output Capability** – Make sure the speaker you choose has adequate power handling and sensitivity to produce the sound levels required. For good paging, the speaker is typically required to sustain average speech levels that are at least 10 dB HIGHER than the ambient noise level.

**Mid & High Frequency Coverage** – Choose a speaker with the appropriate coverage pattern for your application. For intelligibility, select a speaker that has especially even coverage in the 1 kHz through 6 kHz range.

- **Power the Speaker Adequately** – Make sure the speakers are driven with enough amplifier power to sustain the expected sound levels. It doesn't help to have speakers with enough output capability if you don't provide enough amplifier power to drive them to that capability. Clipping of the power amplifier adds considerable distortion, degrades intelligibility, and results in unacceptable sound quality.

Clipping of the power amplifier is especially hard on the high frequency speaker components in a system and can cause damage or failure.

## **Setting SPL Target Goals**

While the JBL Distributed System Design (DSD) software or acoustic design programs (like CADP2 or EASE) can predict HOW the system will perform in the room, the system designer must determine what the GOAL is for each application. The following is intended to help in setting an SPL goal for the system design.

Here are some GENERAL guidelines to use as starting points in your system designs. The SPL levels correspond to the “Maximum Average SPL for Music and Speech” figure listed in DSD (which is 4 dB LESS THAN the computed Maximum Average SPL for Pink Noise).

Factors to consider include the ambient noise, loudspeaker distance from listeners, loudspeaker overlap, the type of program material, and fidelity expectations of the listener.

**Determining SPL ABOVE AMBIENT** -- Economy background music installations require an average music level capability of at least 5 dB above the ambient noise. For good paging intelligibility the system needs a headroom of 10 dB higher than the ambient noise. Levels of 15 to 20 dB above ambient yields excellent intelligibility.

**Table 11:  
Average SPL Targets Above Ambient Noise Level**

|                    |   |
|--------------------|---|
| +5 dB for:         | Economy background music only                     |
| +10 dB for:        | Good paging intelligibility and music quality     |
| +15 to +20 dB for: | Maximum intelligibility and highest dynamic range |

**Finding the AMBIENT SOUND LEVEL** – If the installation is in an existing location that is already in use, use an SPL meter set for slow response to measure the A-weighted ambient sound at the listener’s ear position. Try to take measurements during the noisiest time and make sure the HVAC (air handling) system is operating during the test. If the installation will be in a new facility, try to measure the ambient sound level in a similar type venue.

## **Equalizing Ceiling Speakers**

Setting EQ for ceiling speakers can be different than with sound reinforcement speakers. Incorrect measurement techniques will result in poor system performance. For example, positioning of the measurement mic in the overlap region between adjacent speakers can lead to faulty measurements, due to specific cancellations or additions that are NOT representative of the listening space as a whole. In addition, more than a few installers have tried to equalize for floor reflections, sometimes resulting in large boosts and cuts in adjacent EQ filter bands. You can NOT equalize for floor reflections (or for any other reflections).

**Microphone Placement Within Speaker Coverage Pattern** – Place the microphone either on-axis or up to 20 degrees off-axis. Try to be within the coverage pattern of only a single speaker. When you equalize on-axis, you equalize the direct sound in the mid/high frequencies, while taking the low-frequency summation of adjacent speakers into consideration.

**Mic Height** – While it is best to place the microphone at the typical listening height for the application, unfortunately the measurements can be contaminated by floor reflections that can artificially add or subtract to various frequencies as displayed on your test equipment shows. For example, a measurement taken at a 4 foot (1.2 m) height may show dips at odd multiples of 80 Hz (240 Hz, 400 Hz, 560 Hz, 720 Hz, 880 Hz, etc) and peaks at even multiples of 80 Hz (160 Hz, 320 Hz, 480 Hz, 640 Hz, etc). Depending on the resolution and bandwidth characteristics of your measuring device, these can show up as various boosts and dips in your measurement bands. These reflections are NOT equalizable. It is best to eliminate floor reflections from your measurement.

**Eliminating Floor Reflections via Mic Positioning** – To eliminate the floor reflection from your measurements, use the microphone in “PZM (pressure zone mic) Mode” by placing the mic on a hard surface on the ground or by setting it on a large piece of plywood at ear height. For this type of measurement, the microphone is typically laid on its side slightly off-center of the plywood. The reason for off-center placement is to minimize complications from the addition of symmetrical diffraction effects from the edges of the plywood plane. Placement about 4 to 6 inches away from the center point, toward one of the corners, is appropriate.

To maximize the high frequency accuracy, make sure that the microphone diaphragm is as close to the plywood plane surface as possible. If the natural contour of the mic case makes the element sit off the surface, it is beneficial to angle the case such that the mic diaphragm is within ¼” (6 mm) of the wood surface, without actually touching the wood surface.

**Microphone Type** – Use an instrumentation-grade microphone. To get the most accurate measurement in PZM mode (see above), a small-diaphragm mic with small housing is best because it allows the mic diaphragm to get as close as possible to the plywood, minimizing any interference between direct waves and those reflected back onto the diaphragm from the plywood itself, thereby minimizing false information.

**Equalization** – With proper microphone and mic positioning, set the equalization for as smooth a response as possible. As with all equalization, be wary of large boosts and cuts in adjacent filter bands. Use equalization gently. Do NOT try to equalize reflections because they change with every mic position in the room. If you’re not sure what’s real, move the mic to a number of locations. It is also useful to average a number of locations.

## Low-Impedance vs. 70V/100V Speakers

Control Contractor ceiling speakers come in low-impedance (“non-T”) and 70V/100V (“T”) versions. There are different types of power amplifiers for driving each of these types of speakers. Make sure to use the correct amplifier type specifically designed to drive the type of speaker you are using.

### Low Impedance (8 Ω to 16 Ω) Speakers

- Low impedance speakers have a direct connection from the power amplifier, resulting in more efficient transfer of power for short and medium cable runs. There is no input transformer on the speaker and the amplifiers don’t have output transformers, each of which can reduce the total power delivered to the speakers.
- Low impedance speakers often provide higher headroom, both within the speaker and from the amplifier.
- Low impedance speakers provide greater output level because of not being limited by the power tap setting of a 70V/100V speaker.

**Impedance Considerations** – The impedance of the Control 24C and Control 26C is 16 ohms, NOT 8 ohms as is typical of most ceiling speakers. It is important to NOT present a lower impedance load to the amp than the amp is capable of handling. The 16 ohm impedance allows connection of more speakers on each channel of an amplifier. Many low-impedance amplifiers accept loads of 4 ohms or 2 ohms. It is possible to connect as many as four (4) Control 24C or Control 26C speakers in parallel to each channel of a 4-ohm-capable amplifier, and as many as eight (8) speakers in parallel to each channel of a 2-ohm-capable amp.

By using a 2-ohm-capable amp, it is possible to connect a sixteen (16) speaker stereo system, eight (8) speakers per channel, without having to use 70V/100V speakers.

The Control 19CS subwoofer is different from the other models in that it is 8 ohms, not 16 ohms. In this way, it can get as much power as possible from the power amplifier, even when only one (1) or two (2) subwoofers is utilized.

### Formulas for Parallel Speakers:

When speakers are the SAME impedance as each other:

$$T = R/N$$

T is the total impedance

R is the impedance of a single speaker

N is the number of speakers

When Speakers are DIFFERENT Impedances:

$$T = 1 / (1/R_1 + 1/R_2 + 1/R_3 . . . )$$

T is the total impedance

R<sub>1</sub>, R<sub>2</sub>, R<sub>3</sub> are the impedances of the individual speakers (include all speakers)

### 70V/100V Speakers:

- 70V/100V speakers are a good choice if you are using so many speakers that the impedance would be too low for a low-impedance amplifier to drive.
- 70V/100V speakers allow individual adjustment of the level of each speaker up or down (using the tap selector switch).
- 70V/100V speakers are often easier to configure into systems with complex zoning and level control requirements.
- 70V/100V lines can transfer power more effectively using considerably smaller gauge speaker cables, which can result in significant cost savings on longer cable runs.
- The Control Contractor’s 70V/100V transformers are of a very good quality, where they do not saturate easily at low frequencies. With other brands of speakers, transformer saturation from inexpensive transformers or autoformers can cause unpleasant distortion at all levels and often prevents operating the speakers below 100 Hz.

## 70V/100V Power Amplifier Considerations

**a) Sizing** – Add up the total wattage of all the taps you are connecting to the 70V/100V line. It is an accepted rule-of-thumb to add 20% to this figure to make sure that the amplifier does not get over-taxed. For example, if you are connecting six (6) speakers tapped at 15 watts, the amplifier should be rated at 108 watts or higher.

**b) Low Frequency Capability** – Many 70V/100V power amplifiers on the market today are from the era when business music systems extending only down to 100 Hz were widely accepted. These less expensive amplifiers are not capable of driving today's high fidelity systems that require sound below 100 Hz. Unless you plan on high-passing the system at 100 Hz, it is VERY IMPORTANT to use a power amplifier capable of full output down to and below the lowest frequency going INTO the amp, which is often around 50 Hz. An amplifier with low-frequency capability is absolutely crucial whenever the system includes a subwoofer, and is very important for today's high fidelity business music systems.

## Connection of Low-Impedance Speaker Systems

### Parallel Hookup of Low Impedance Speakers (Control 24C or 26C)

*(mono shown — duplicate for stereo)*

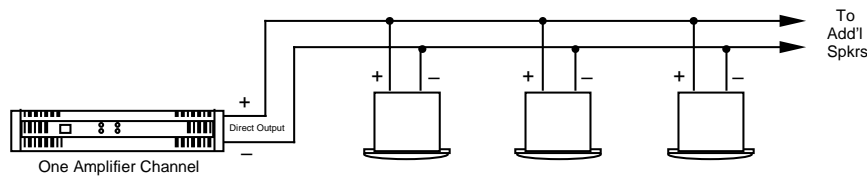

### Parallel Hookup of Low Impedance Full-Range Speakers with C19CS Subwoofer

*(mono shown — duplicate for stereo)*

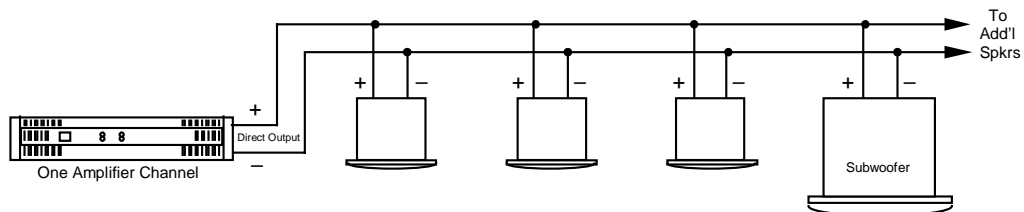

### Bi-Amplified Hookup of Full-Range (or High-Passed) Speakers with C19CS Subwoofer

*(mono shown — duplicate for stereo)*

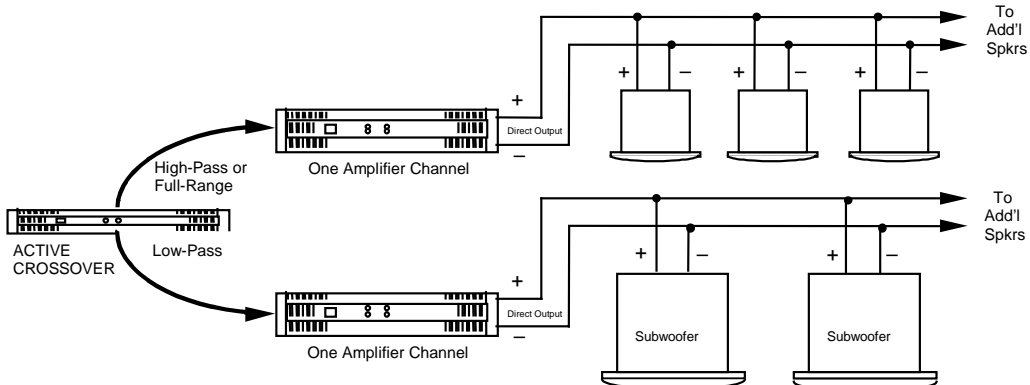

## Connection of 70V/100V Speaker System

### Parallel Hookup of 70V/100V Impedance Speakers (Control 24CT or 26CT) *(mono shown — duplicate for stereo)*

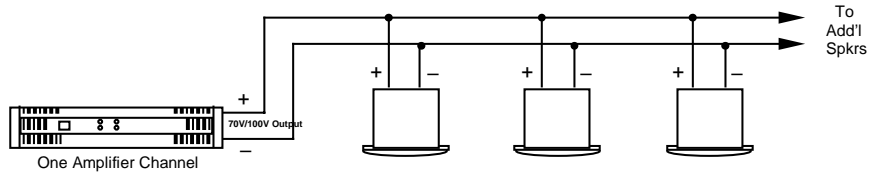

### Parallel Hookup of 70V/100V Full-Range Speakers with C19CST 70V/100V Subwoofer *(mono shown — duplicate for stereo)*

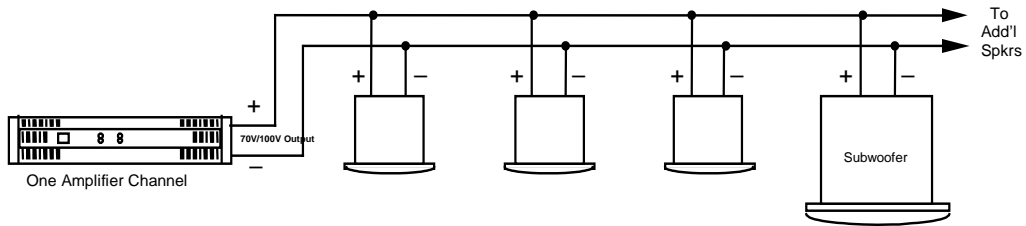

### Bi-Amplified Hookup of 70V/100V Full-Range (or High-Passed) Speakers with C19CS Subwoofer *(mono shown — duplicate for stereo)*

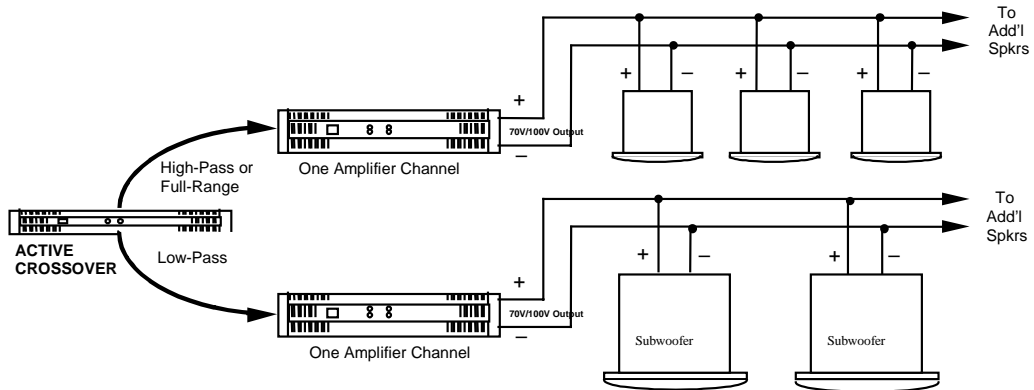

## Connection of Hybrid Bi-Amplified Speaker System

### 70V/100V Full-Range (or High-Passed) Speakers and Low Impedance Control 19CS Subwoofers (mono shown — duplicate for stereo, or use crossover that provides mono subwoofer feed)

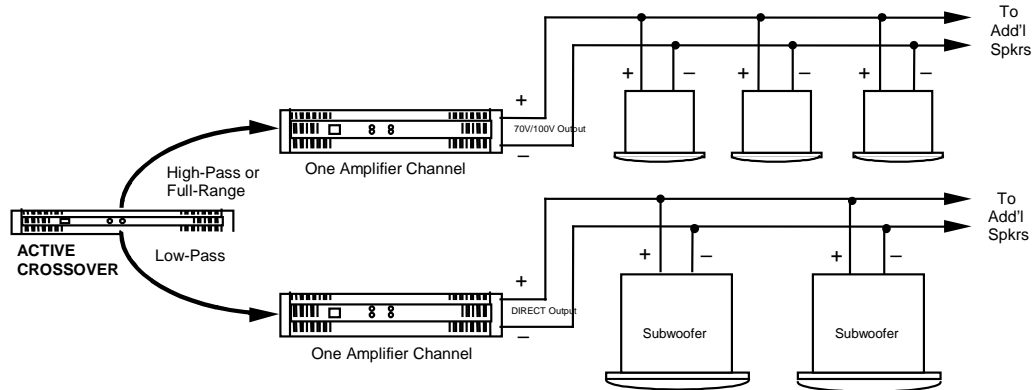

*Note: JBL MPC-T amplifiers have the ability to simultaneously drive a 70V/100V line from one channel and low impedance speakers on the other channel, such as shown in diagram.*

## Stereo Distributed Systems

Stereo systems are becoming popular in higher-end business music applications. Stereo can add a sense of spaciousness to the listening environment, but is slightly more expensive to implement. Stereo requires additional amplification channels and sometimes a more expensive controller/mixer/preamp. It also requires a stereo source and more complex line and loudspeaker wiring.

**Speaker Expense for Stereo** – Stereo often does NOT require much higher expense when it comes to the loudspeaker portion of the system. With the importance of audio to the business music environment, it is often worth the additional cost to make the system stereo instead of mono.

**Speaker Density for Stereo** – While stereo can be accomplished adequately with the normal mono layout density, there are opportunities for even better stereo sound by selecting one of the tighter density patterns.

**Left/Right Configuration** – Laying out a distributed system stereo is simply a matter of assigning every other speaker as a left or a right speaker. In this way – with the left and right speakers staggered throughout the room – there is no “true” left or right side of the room. Regardless where a listener is located in the room, they hear both the right and left channels from nearby speakers. Even those listeners located right under one of the speakers hear some of the other channel from the adjacent speakers.

**Paging in Stereo Systems** – It is important that the paging signal go to BOTH the left and right channels equally so that pages come through in mono and everyone can hear them.

## **Additional Application Support**

Additional application information is available from the following reference sources:

Sound System Engineering, Davis and Davis  
Howard W. Sams & Co. (1987)

Electroacoustical Reference Data, Eargle  
Van Nostrand Reinhold (1994)

Handbook for Sound Engineers, The New Audio Cyclopedia, Ballou, ed.  
Howard W. Sams & Co. (1991)

Handbook of Sound System Design, Eargle  
ELAR Publishing Co (1989)

For additional application support from JBL Professional:

WITHIN THE UNITED STATES: Contact Applications Support, JBL Professional, PO Box 2200,  
8500 Balboa Blvd, Northridge CA 91329 USA. In the USA call Monday through Friday 8:00 am  
to 5:00 pm Pacific Coast Time (818) 894-8850.

IN OTHER AREAS THROUGHOUT THE WORLD: Contact the JBL Distributor for your region.

JBL PRO WEBSITE: [www.jblpro.com](http://www.jblpro.com)



JBL Professional  
8500 Balboa Blvd, P.O. Box 2200  
Northridge, CA 91329 U.S.A.



A Harman International Company

CS APP GUIDE  
Rev A