

**JBL**

# VP7210/95DP

## Powered 10" 2-Way Integrated Loudspeaker System

Professional Series

### Key Features:

- ▶ Compact Powered bi-amplified full-range loudspeaker with JBL DrivePack® technology for portable or installed use
- ▶ Optimized for both portable/rental or permanent-venue use
- ▶ 1750 watts peak output power, 875 watts continuous
- ▶ 10-inch Differential Drive® low-frequency driver for extended low-frequency output
- ▶ Robust powder-coated die cast aluminum handles, designed for strength and comfort

### Applications:

- ▶ High-impact audio/visual presentations
- ▶ Theatrical stage sound design
- ▶ Houses of Worship
- ▶ Live performance venues
- ▶ Performing arts centers
- ▶ Corporate learning centers
- ▶ Themed entertainment venues
- ▶ Sound reinforcement rental companies

The VP7210/95DP is a powered 10" 2-way integrated loudspeaker system featuring 1750 watts of peak output power, and onboard digital signal processing.

Designed in cooperation with Crown International, the JBL DrivePack® DPC-2 amplifier module features Crown's Class D digital power amplification circuitry.

DBT (Dual-Bridged Technology™) directly links discrete amplifier channel outputs to each voice-coil in the Differential Drive loudspeaker. Electrical power transfer to the transducer is optimized for maximum system performance.

VP7210/95DP transducers are JBL's 2260FF 10" diameter Differential Drive woofer and the JBL 2452H-SL compression driver. The high frequency driver is coupled to a JBL PT-D95HF Progressive Transition™ (PT) Waveguide for excellent 90° x 50° pattern control, smooth frequency response, and low distortion. Easily rotated for horizontal or vertical system orientation.

The VP7210/95DP is equipped with an integrated 35 mm stand mount.



### Specifications:

Frequency Response (+/-3 dB):	80 Hz – 20 kHz
Frequency Range (-10 dB):	50 Hz – 20 kHz
Coverage Pattern:	90° x 50° rotatable waveguide
Directivity Factor (Q):	10
Directivity Index (DI):	10 dB
Maximum Peak Output <sup>1</sup> :	132 dB SPL 1m
<b>Transducer Section:</b>	
Low Frequency Section:	JBL 2261FF, 254 mm (10 in) dia., 76 mm (3 in) Dual Coil neodymium Differential Drive®, Direct Cooled
Bandpass Nominal Impedance:	2 x 2 ohms
High Frequency:	JBL2452H-SL, 100 mm (4 in) titanium damped diaphragm, 1.5 in. exit.
Bandpass Nominal Impedance:	8 ohms
<b>System:</b>	
DPC-2 Internal Amplification Output (at nominal load)	875 Watts Continuous
DPC-2 Output (Continuous IEC shaped pink noise into rated load impedance):	750LF/125HF Watts
DPC-2 Output Section:	LF: Dual Bridged Technology™, Class D HF: Bridged Class D
Audio Input connector	XLR with loop-through
User Controls:	80 Hz Subwoofer High Pass Filter. Enable/Disable 0-16 dB input Attenuator with 32 precision 0.5 dB steps
Signal Processing:	DSP based, resident in Input Module.
System Management:	DSP based limiters for mechanical and thermal protection
AC Power Operating Range:	90-132 VAC/216-264 VAC, 50/60 Hz
AC Line Voltage:	50/60 Hz; User Selectable; 120V/240V (-15%, +10%)
AC Input Connector:	Neutrik PowerCon (NAC 3MPA)
AC Loop-thru:	Neutrik PowerCon (NAC 3MPB)
AC Current Requirement:	6A per system at 120V, 3A per system at 240V
<b>Enclosure:</b>	
Box Construction:	5/8 in. multi-ply exterior grade Baltic birch. Internally braced. Black DuraFlex™ finish.
Suspension System:	9 M10 Fittings, 2 M6 Fittings, 35 mm pole mount socket
Grille:	14 Gauge Black powder-coated perforated steel with foam backing.
Dimensions (H x W x D):	521 x 293 x 303 mm 20.5 x 11.5 x 11.9 in
Net Weight:	18.4 kg (40.5 lbs)

<sup>1</sup>Measured with IEC shaped noise in free field conditions.

# ▶ VP7210/95DP Powered 10" 2-Way Integrated Loudspeaker System

Frequency Response

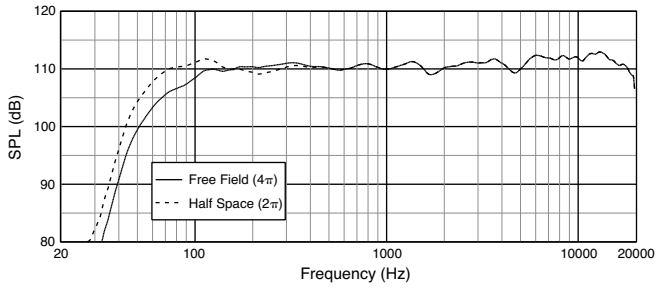

Horizontal Off-Axis Frequency Response

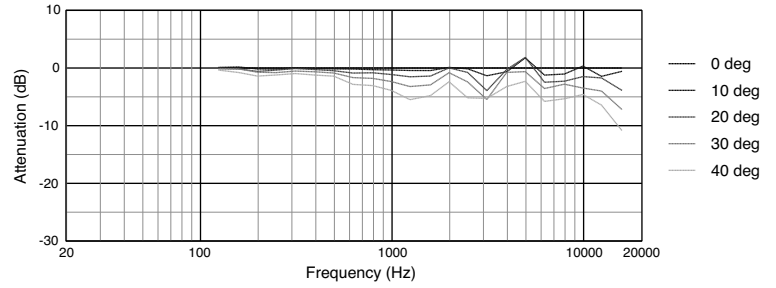

Beamwidth

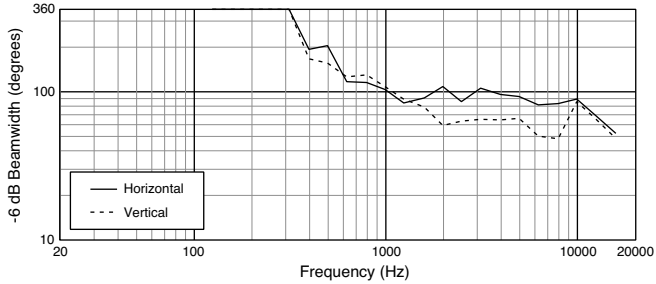

Vertical Off-Axis Frequency Response

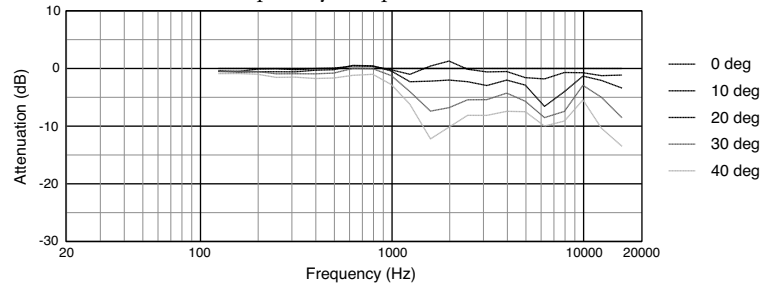

Directivity Index, Q

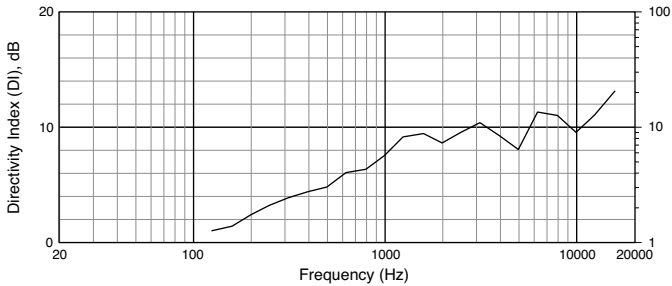

Vertical Down Off-Axis Frequency Response

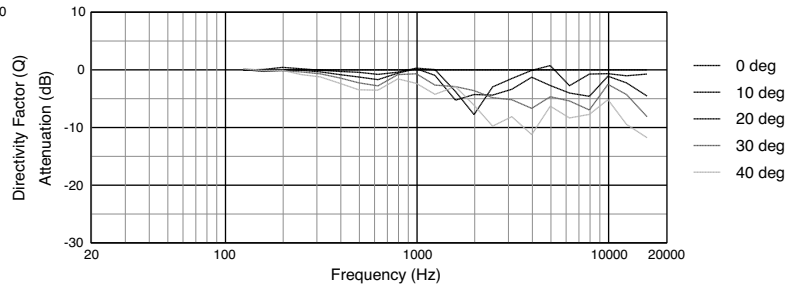

## Dimensions

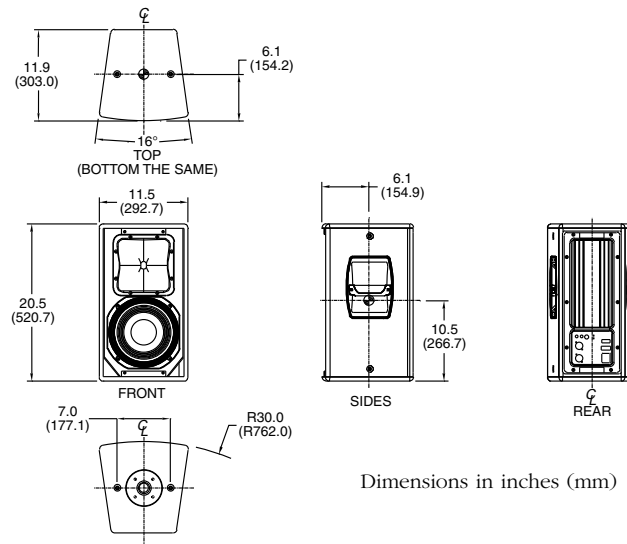

Dimensions in inches (mm)

## Accessories:

JBL offers a wide variety of accessories including rigging accessories and transport covers. Please visit [www.jblpro.com](http://www.jblpro.com) for a complete list of VP Series accessories.



**VP SERIES**  
venue performance



JBL Professional  
8500 Balboa Boulevard, P.O. Box 2200  
Northridge, California 91329 U.S.A.

© Copyright 2013 JBL Professional  
[www.jblpro.com](http://www.jblpro.com)

SS VP7210/95DP  
CRP 5M  
12/13