

# DS115



## Datasheet

Applies to Part Number: 587000 / 587001

## Intellivox - DS115

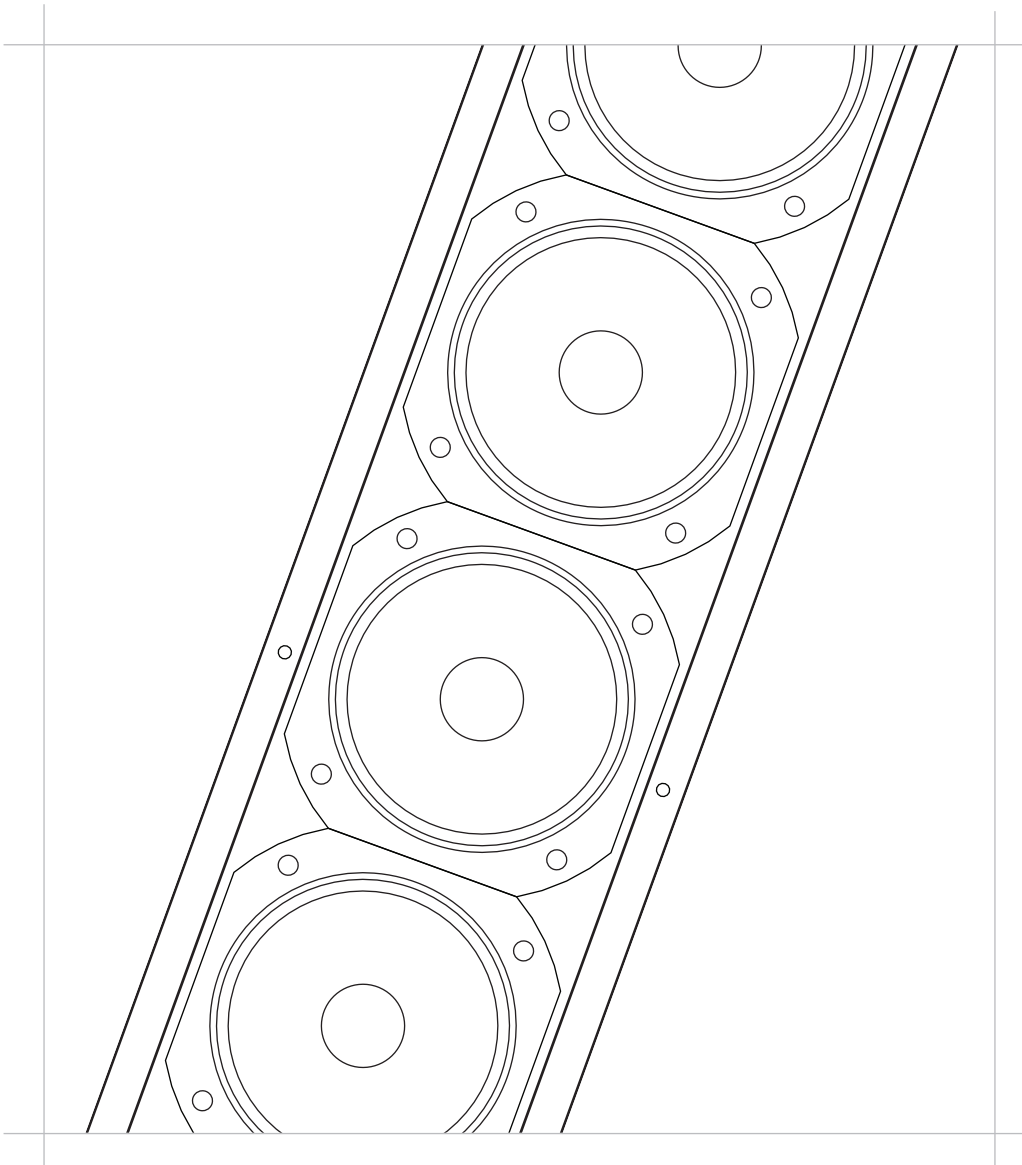

## User Notice:

- No part of this document including the software described in it may be reproduced, transmitted, transcribed, stored in a database system or translated without the express written permission of JBL Professional. Documentation kept by the end-user for backup purposes is excluded from the above mentioned.
- All products and corporate names mentioned in this document may be registered trademarks or copyrights of their respective companies. They are used here for indicative purposes only.
- The information contained in this document has been carefully checked for accuracy, however no guarantee is given with respect to the correctness. JBL Professional accepts no responsibility or liability for any errors or inaccuracies that may appear in this document or the products and/or software described in it.
- Specifications and information contained in this document are subject to change at any time without notice.

## Table of Contents

1. Architectural and engineering specifications . . . . .	4-5
2. Specifications . . . . .	6-7
3. Mechanical details . . . . .	8-9
4. Optional Accessories . . . . .	10
5. DSP block diagram . . . . .	11

# 1. Architectural and engineering specifications

The unit shall be constructed as a line-array of six 4" full-range loudspeakers equipped with moisture resistant diaphragms and two coaxially mounted tweeters.

All signal processing functions, necessary to properly drive a directivity controlled line-array with electrical aiming properties, shall be implemented on-board in order to reduce the overhead costs related to external connections. The complete electronics shall be mounted on a chassis which is placed in a separated compartment at the front-side of the enclosure. Electronics shall consist of an audio input module, two input / eight output channel DSP section, eight power amplifiers with protection circuitry (each power amplifier shall drive one loudspeaker) and a switched-mode power supply.

The input section shall be transformer balanced. All necessary array signal processing shall be implemented in the digital domain by means of a 900MFLOPS 32bits DSP. The DSP shall realize appropriate output channel filters and delays. Besides the aforementioned, the

DSP shall be able to realize EQ, pre-delay, volume and autogain, and compression as required. The DSP software and coefficients shall reside in non-volatile memory in order to facilitate adaptations and software updates.

The control unit shall be equipped with a fully isolated RS-485 based full-duplex serial network interface. This control unit shall serve three main functions:

- Remote monitoring of parameters like status of the DSP, amplifiers and loads, external pilot tone, status of the ambient noise sensing microphone, chassis temperature, ambient noise level, ambient temperature, control for the input section etc.
- Remote control of beam parameters, volume and analog pre-gain, pre-delay, EQ, autogain configuration and surveillance related parameters.
- Updating DSP software and factory unit programming.

The audio signal shall be connected to a 6p male 5 mm pitch cage clamp connector (as WAGO series 231). The RS-485 signal shall be connected to a 5p cage clamp connector of the same type as specified above. The unit shall be equipped with a 3p male IEC mains supply connector. All connectors shall be grouped together on the electronics chassis and shall be accessible from the front and the rear of the unit.

The enclosure shall be constructed of steel finished with an epoxy coating. At the back side of the enclosure a total of two bracket attachment points shall be provided (located near the outer ends). The protective front shall consist of a perforated steel grill which can be clicked onto four snap-in studs mounted on the enclosure.

The complete loudspeaker unit shall meet the following criteria:

Typical frequency range of the complete array 130 - 20k Hz on axis (+/- 3 dB), max. SPL at 30 m of 85 dB<sub>SPL</sub> continuous and 88 dB<sub>SPL</sub> peak, adjustable vertical beam shape is defined by the DDS (Digital Directivity Synthesis) algorithm, fixed horizontal opening angle of 130° (-6 dB, averaged 1k to 4k Hz).

Dimensions are 1149 mm (45.2") H x 134 mm (5.3") W x (3.6") 92 mm D.

Weight 13 kg (28 lbs).

The loudspeaker unit shall be the JBL Professional® model Intellivox-DS115.

## 2. Specifications

### Acoustical:<sup>1</sup>

Freq range <sup>2</sup>	- 4" loudspeaker	: 230 - 10k Hz (+/-3 dB)
	- 10 mm tweeter	: 6k - 20k Hz (+/-3 dB)
	- Complete array	: 130 - 20k Hz (+/-3 dB)
Max SPL <sup>3</sup>	- Continuous	: 85 dB <sub>SPL</sub> (A-weighted at 30 m)
	- Peak	: 88 dB <sub>SPL</sub> (A-weighted at 30 m)
Coverage	- Horizontal (fixed)	: 130 deg (-6 dB, averaged 1k to 4k Hz)
	- Vertical (adjustable)	: defined by the DDS algorithm
	- Typical throw	: 15 m
Dynamic range <sup>4</sup>		: >100 dB

### Electrical:

Input <sup>5</sup>	- Nominal level	: 0 dBV (RMS, line input)
	- Maximum level	: +19 dBV (peak, line input)
	- Type	: dual line input, transformer balanced
	- Impedance (balanced)	: 6k8 Ω
DSP module	- Type	: floating point 900 MFLOPS 32 bits
	- Memory	: 64 Mb SDRAM + 3 Mb non volatile
	- AD - DA conversion:	: 24 bits sigma-delta 128 x oversampling
	- Auxilliary processor	: 200 nsec single cycle RISC
	- Sample rate	: 48.8 kHz (default)
	- Latency <sup>6</sup>	: 3.7 ms
	- Signal processing <sup>7</sup>	: - 21 sec (pre-delay) + 2 x 10 sec (input channel delay) - equalizer and compensation filtering - volume - individual RMS and peak limiters on each output - ambient noise level dependent gain adaptation ('fail-safe') - eight output filters + delay ringbuffers - dual input configuration
Control unit	- Network interface type	: serial full-duplex RS-485, autoswitching 115k2, 57k6, 38k4, 19k2 baud, optically isolated
	- Maximum number of units <sup>8</sup>	: 126 units
	- Remote surveillance	: - general status (DSP running, signal present etc.) - amplifier monitoring and load monitoring schemes - external pilot tone detection (20k5 - 28k Hz, level >= -22 dBV) - built-in ambient noise microphone, override through external ambient mic - frost protection - fan control for optional external fan (24 V DC / 3 W max.) - thermal overload protection
	- Failure	: - internal hardware bypass circuit - failure relay (external connector, maskable conditions) SPDT 100 mA / 24 V - jumper configurable for volt-free or impedance-sensing (10k / 20k Ω) operation - failure status can be indicated at front by bi-colour LED
Power amps	- Type	: PWM (class D)
	- Power	: 8 x 40 W <sub>rms</sub> (4 ohm)
	- Protection	: - thermal shutdown if T <sub>junction</sub> > 150 °C - current limiting output stage

Connectors	- General type	: 5 mm pitch cage clamp (as WAGO series 231)	
	- Audio inputs	: 6p male p1 = Line 1 +, p2 = Line 1 -, p3 = GND p4 = Line 2 +, p5 = Line 2 -, p6 = GND	
	- RS-485 interface	: 5p male p1 = A, p2 = B, p3 = Z, p4 = Y, p5 = DGND	
	- Ambient noise and temp sensor	: 5p female p1 = MIC, p2 = AGND, p3 = NTC, p4 = AGND, p5 = GND	
	- Failure detect and fan control	: 5p female failure relay <sup>9</sup> : p1 = COM, p2 = NO, p3 = NC optional fan : p4 = +24 V, p5 = -	
	- Mains	: 3p IEC	
	PSU	- Mains voltage (+5/-10 %) <sup>10</sup>	: 230 or 115 V
		- Mains fuse(s)	: 1 x 6.3 A (slow type)
		- Power consumption <sup>11</sup>	: 58 VA (idle) / 175 VA (male speech STIPA) / 325 VA (full load)
		- Power factor	: 0.55 (idle) / 0.60 (full load)
- Max mains inrush current		: 25 A short-time peak (@ 230 V)	
- Protection		: - thermal protection - output current limiting - under-voltage lock out	

**General:**

Temperature range (ambient)	: 0 to 40 °C (32 - 104 °F)	
Transducers	: 6 x 4" full range : 2 x 10 mm ferrofluid cooled tweeter, coaxially mounted	
Dimensions (H x W x D) <sup>12</sup>	: 1149 mm (45.2") x 134 mm (5.3") x 92 mm (3.6")	
Default colour	- Enclosure and grill	: RAL 9010 (white)
	- Speaker baffle	: RAL 9011 (black)
Weight	: 13 kg (28 lbs)	
Standards	- Safety	: EN 62368-1:2014+A11:2017
	- EMC	: EN 55032:2012/AC:2013 class A : EN 55103-2:2009
	- Mains harmonics	: EN 61000-3-2:2014
	Certificates	: CE, CSA/UL, CCC

**Notes:**

1. Measured outside under semi-anechoic 'full-space' conditions with typical filter and delay settings unless stated otherwise.
  2. Single transducer data is determined from 1/3 octave averaged data measured on-axis. The frequency response of the complete array is depending on the actual signal processing parameters and air absorption (at larger distances). A typical bandwidth is specified for the complete array under 'full-space' radiation conditions.
  3. Levels are valid for pink noise (100 to 20k Hz bandwidth) with a crest factor of 3 dB. Default EQ and minimum opening angle setting. 'Continuous' is the RMS level, 'Peak' is the absolute peak level, both determined at the onset of the output limiters.
  4. For this measurement the signals at all power amplifier outputs are summed together. Measured as the A-weighted difference (in dB) between the maximum rms level (with pink noise input signal) and the noise output (with no input signal present).
  5. Specs valid for default dual line level input board. Note that other input board options are available: Dual 100V with DC blocking (Order SKU: IVX-381005), 1 x Line Level & 1 x 100V (Order SKU: IVX-381001)
  6. Minimum latency due to hardware and frame processing from analogue input to amplifier output.
  7. Additional processing capabilities available.
  8. Maximum number that can be connected to one RS-485 subnet, multiple subnets can be controlled by one host PC.
  9. For volt-free operation COM is connected to NC if the device is switched-on and has no failure.
  10. Mains voltage can be selected on the switched-mode power supply inside the unit.
  11. Defined as the rms mains current multiplied by the rms mains voltage under normal operating conditions. 'Full load' figures are maximum values measured with a pulsating pink noise input signal.
  12. Depth of enclosure only, without mounting brackets.
- Note: SPL values will vary depending upon opening angle, DDA should be used to verify SPL values for each individual installation.

### 3. Mechanical Details (Order SKU: IVX-587000)

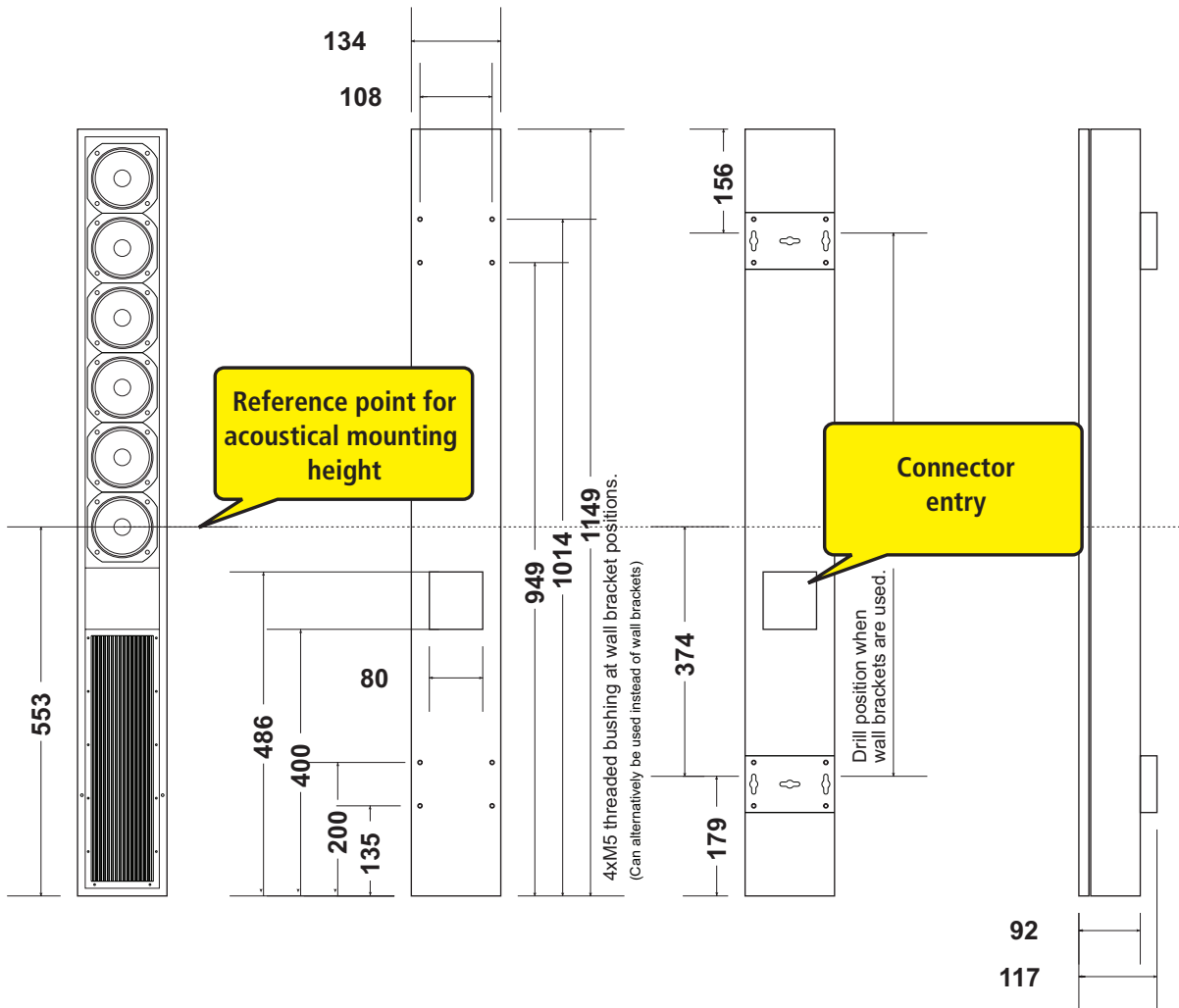

This drawing is valid for the default 'amp-at-bottom' version - Order SKU: IVX-587000



### 3. Mechanical Details (Order SKU: IVX-587001)

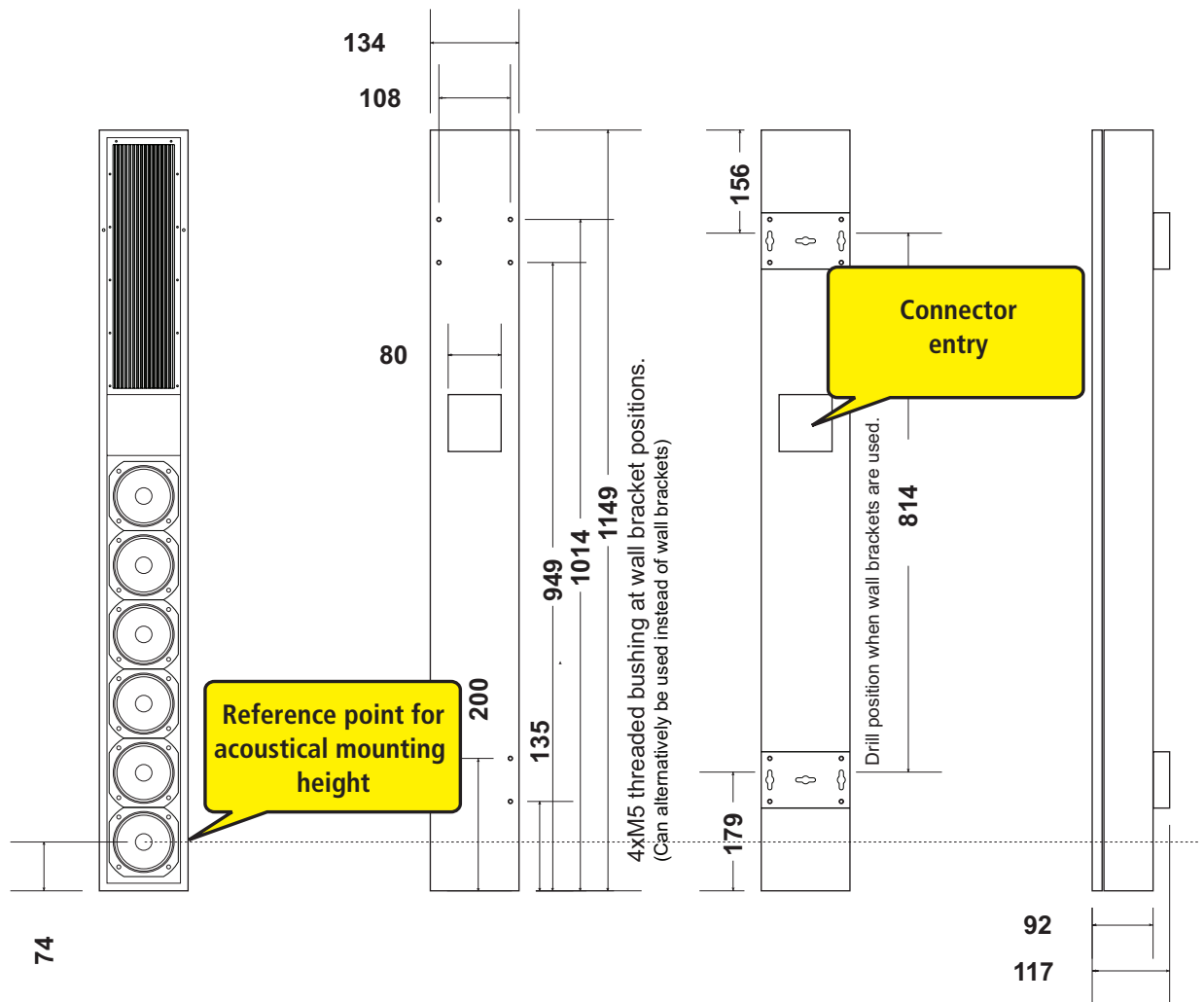

This drawing is valid for the 'amp-at-top' version - Order SKU: IVX-587001

## 4. Optional Accessories

**Wall Bracket (25 mm)**  
**(Supplied as standard)**  
 (2 pcs incl. fasteners)  
 Standard colour RAL 9010



**Swivel Bracket 90°**  
 Order SKU: IVX-806608  
 (1 pcs per pack)  
 Standard colour RAL 9010

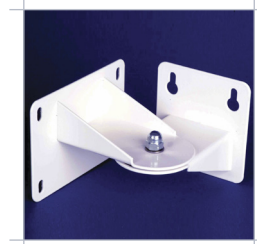

**Swivel Bracket 45°**  
 Order SKU: IVX-806618  
 (1 pcs per pack)  
 Standard colour RAL 9010

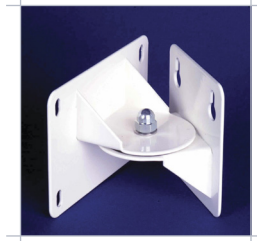

**Cover Plate**  
 2x PG13.5 holes for cable gland  
 Order SKU: IVX-802110  
 Standard colour RAL 9010

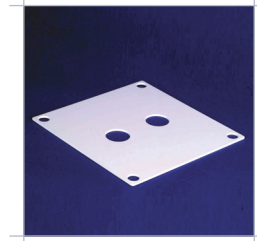

**Hinge Bracket 90°**  
 Order SKU: IVX-802000  
 (1 pcs per pack)  
 Standard colour RAL 9010

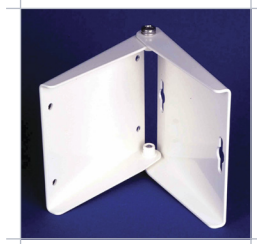

**Cover Box 58 mm**  
 2x25mm holes for cable gland  
 Order SKU: IVX-802100  
 Standard colour RAL 9010

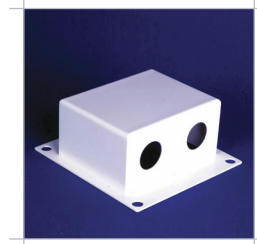

**Program Set**  
**Universal USB**  
 Order SKU: DUR386612



## 5. DSP Block Diagram

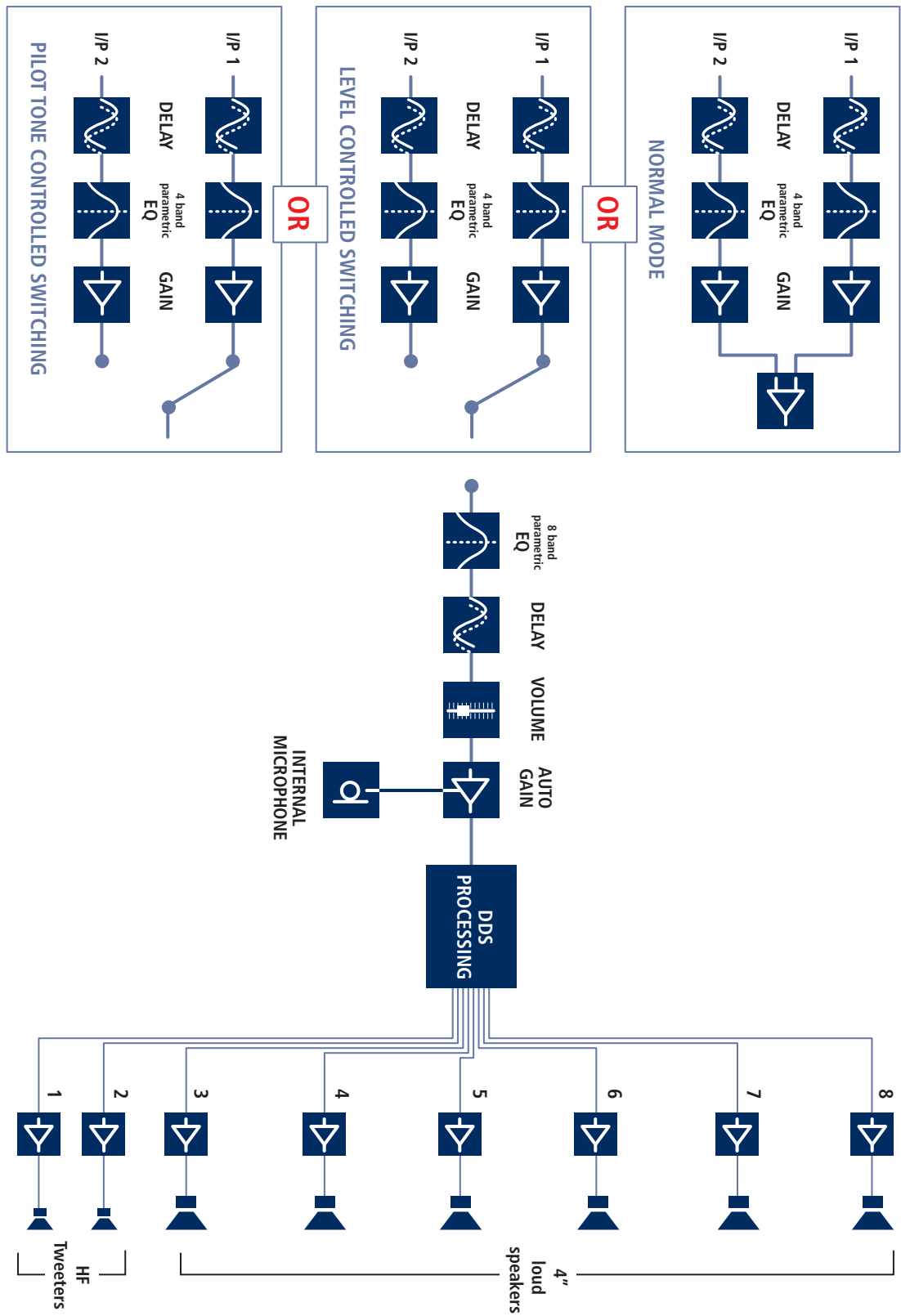



**JBL Professional**

8500 Balboa Boulevard  
Northridge, CA 91329 U.S.A.

© Copyright 2020 JBL Professional  
[www.jblpro.com](http://www.jblpro.com)