



USER MANUAL

Intellivox

Intellivox Dante® DS and DSX Series Loudspeakers



DS115D



DS180D /
DSX180D



DS280D /
DSX280D



DS380D /
DSX380D



DS430D /
DSX430D



DS500D /
DSX500D

IMPORTANT SAFETY INSTRUCTIONS

1. READ these instructions.
2. KEEP these instructions.
3. HEED all warnings.
4. FOLLOW all instructions.
5. DO NOT use this apparatus near water.
6. CLEAN ONLY with dry cloth.
7. DO NOT block any ventilation openings. Install in accordance with the manufacturer's instructions.
8. DO NOT install near any heat sources such as radiators, heat registers, stoves, or other apparatus (including amplifiers) that produce heat.
9. DO NOT defeat the safety purpose of the polarized or grounding type plug. A polarized plug has two blades with one wider than the other. A grounding type plug has two blades and a third grounding prong. The wider blade or the third prong are provided for your safety. If the provided plug does not fit into your outlet, consult an electrician for replacement of the obsolete outlet.
10. PROTECT the power cord from being walked on or pinched, particularly at plugs, convenience receptacles, and the point where they exit from the apparatus.
11. ONLY USE attachments/accessories specified by the manufacturer.
12. CAUTION: Use only with a cart, stand, tripod, bracket, or table specified by the manufacturer, or sold with the apparatus. When a cart is used, use caution when moving the cart/apparatus combination to avoid injury from tip-over. Use with other equipment or carts may result in instability causing injury.
13. UNPLUG this apparatus during lightning storms or when unused for long periods of time.
14. REFER all servicing to qualified service personnel. Servicing is required when the apparatus has been damaged in any way, such as power-supply cord or plug is damaged, liquid has been spilled on objects have fallen into the apparatus, the apparatus has been exposed to rain or moisture, does not operate normally, or has been dropped.
15. To completely disconnect this apparatus from the AC Mains, disconnect the power supply cord plug from the AC receptacle.
16. Where the mains plug or an appliance coupler is used as the disconnect device, the disconnect device shall remain readily operable.
17. DO NOT overload wall outlets or extension cords beyond their rated capacity as this can cause electric shock or fire.
18. Follow all locally applicable laws, codes and regulations when installing, powering, operating or servicing the product.
19. Install and operate only as directed or a safety hazard could be created.



WATCH FOR THESE SYMBOLS:



The exclamation point, within an equilateral triangle, is intended to alert the user to the presence of important operating and maintenance (servicing) instructions in the literature accompanying the product.



The lightning flash with arrowhead symbol within an equilateral triangle is intended to alert the user to the presence of uninsulated "dangerous voltage" within the product's enclosure that may be of sufficient magnitude to constitute a risk of electrical shock to persons.



Read manual before use.



High sound pressure. Hearing damage risk. Do not listen at high volume levels for long periods.

WARNING: To reduce the risk of fire or electrical shock, do not expose this apparatus to rain or moisture.

WARNING: No naked flame sources – such as lighted candles – should be placed on the product.

WARNING: To be installed by instructed or skilled persons only.

This equipment is not suitable for use in locations where children are likely to be present.

WARNING: Equipment shall be connected to a MAINS socket outlet with a protective earthing connection.

CAUTION: To reduce the risk of electric shock, grounding of the center pin of this plug must be maintained.

WARNING: To avoid the risk of electric shock, do not connect the Live or Neutral conductor of power cord to the earthing terminal of the power connector.

WARNING: This product is intended to be operated ONLY from voltages that complies with local building and electrical codes listed on the back panel or the recommended or included power supply of the product. Operation from other voltages other than those indicated may cause irreversible damage to the product and void the products warranty. The use of AC Plug Adapters is cautioned because it can allow the product to be plugged into voltages in which the product was not designed to operate. If you are unsure of the correct operational voltage, please contact your local distributor and/or retailer. If the product is equipped with a detachable power cord, use only the type provided, or specified by the manufacturer or your local distributor.



WARNING: Do Not Open! Risk of Electrical Shock. Voltages in this equipment are hazardous to life. No user-serviceable parts inside. Refer all servicing to qualified service personnel.

Place the equipment near a main power supply outlet and make sure that you can easily access the power breaker switch.

FCC AND CANADA EMC COMPLIANCE INFORMATION:

This device complies with part 15 of the FCC Rules. Operation is subject to the following two conditions:

This device may not cause harmful interference, and

this device must accept any interference received, including interference that may cause undesired operation.

CAN ICES-3 (A) / NMB-3(A)

FCC SDOC SUPPLIER'S DECLARATION OF CONFORMITY:

HARMAN Professional, Inc. hereby declares that this equipment is in compliance with the FCC part 15 Subpart B.

NOTE: This equipment has been tested and found to comply with the limits for a Class A digital device, pursuant to part 15 of the FCC Rules. These limits are designed to provide reasonable protection against harmful interference when the equipment is operated in a commercial environment. This equipment generates, uses, and can radiate radio frequency energy, and if it is not installed and used in accordance with the instruction manual, it may cause harmful interference to radio communications. Operation of this equipment in a residential area is likely to cause harmful interference, in which case the user will be required to correct the interference at his own expense.

WARNING: This product must not be used in residential areas. In a residential environment this equipment may cause radio interference.

CAUTION: Changes or modifications not expressly approved by the manufacturer could void the user's authority to operate this device.

WARNING: This equipment is compliant with Class A of CISPR 32. In a residential environment this equipment may cause radio interference.

NOTE: For interference purposes, the residential and domestic environments are defined as an environment within 10meters of radio or broadcast receiving equipment or home use.

WEEE NOTICE:

The WEEE Directive 2012/19/EU on Waste Electrical and Electronic Equipment (WEEE), which entered into force as European law on 14/02/2014, resulted in a major change in the treatment of electrical equipment at end-of-life.

The purpose of this Directive is, as a first priority, the prevention of WEEE, and in addition, to promote the reuse, recycling and other forms of recovery of such wastes so as to reduce disposal. The WEEE logo on the product or on its box indicating collection for electrical and electronic equipment consists of the crossed-out wheeled bin, as shown below.

This product must not be disposed of or dumped with your other household waste. You are liable of dispose of all your electronic or electrical waste equipment by relocating over to the specified collection point for recycling of such hazardous waste. Isolated collection and proper recovery of your electronic and electrical waste equipment at the time of disposal will allow us to help conserving natural resources. Moreover, proper recycling of the electronic and electrical waste equipment will ensure safety of human health and environment. For more information about electronic and electrical waste equipment disposal, recovery, and collection points, please contact your local city center, household waste disposal service, shop from where you purchased the equipment, or manufacturer of the equipment.



If you have questions about how to install or operate the product, please contact Harman Professional, Inc. Technical support:

Technical support in North America, please contact: HProTechSupportUSA@harman.com Phone: (844) 776-4899

Technical support outside North America, please contact your local distributor.

HARMAN Professional, Inc. 8500 Balboa Blvd. Northridge, CA 91325 USA

EU: HARMAN Professional Denmark ApS Olof Palmes Allé 44, 8200 Aarhus N, Denmark

UK: HARMAN Professional Solutions 2 Westside, London Road, Hemel Hempstead, HP3 9TD, UK



Section 1. Welcome

Thank you for choosing JBL Intellivox Dante DS and DSX series loudspeakers. This manual provides the recommended procedures for safe and effective installation of your system.

The Intellivox Dante product line features active, DSP-controlled loudspeaker arrays that employ multiple individually driven and controlled drivers arranged vertically. The advanced DSP utilizes Digital Directivity Synthesis™ beam shaping algorithms to precisely control sound coverage, allowing you to optimize performance for a wide range of acoustic environments.

It is strongly recommended that users review this manual in full before placing an order or beginning installation to ensure proper preparation and reliable operation.

INFORMATION IN THIS MANUAL

This manual describes the following aspects of installation:

- Preparing for installation
- Necessary cabling
- Connector wiring
- Mechanical installation
- Software Setup

APPLICABLE MODELS, AND VARIANTS

This manual contains installation instructions for the following products. All models in the DS range consist of a single type of driver, while the products in the DSX range consist of two types of drivers. The three-digit number signifies the height of the product (in centimeters).

INTELLIVOX HEIGHT COMPARISON BY MODEL

INTELLIVOX DS RANGE	INTELLIVOX DSX RANGE
DS115D*	
DS180D	DSX180D
DS280D	DSX280D
DS380D	DSX380D
DS430D	DSX430D
DS500D	DSX500D

*The DS115 has two types of drivers. Note: DS models are the same dimensions as DSX models. DSX drawings are used for size comparison.

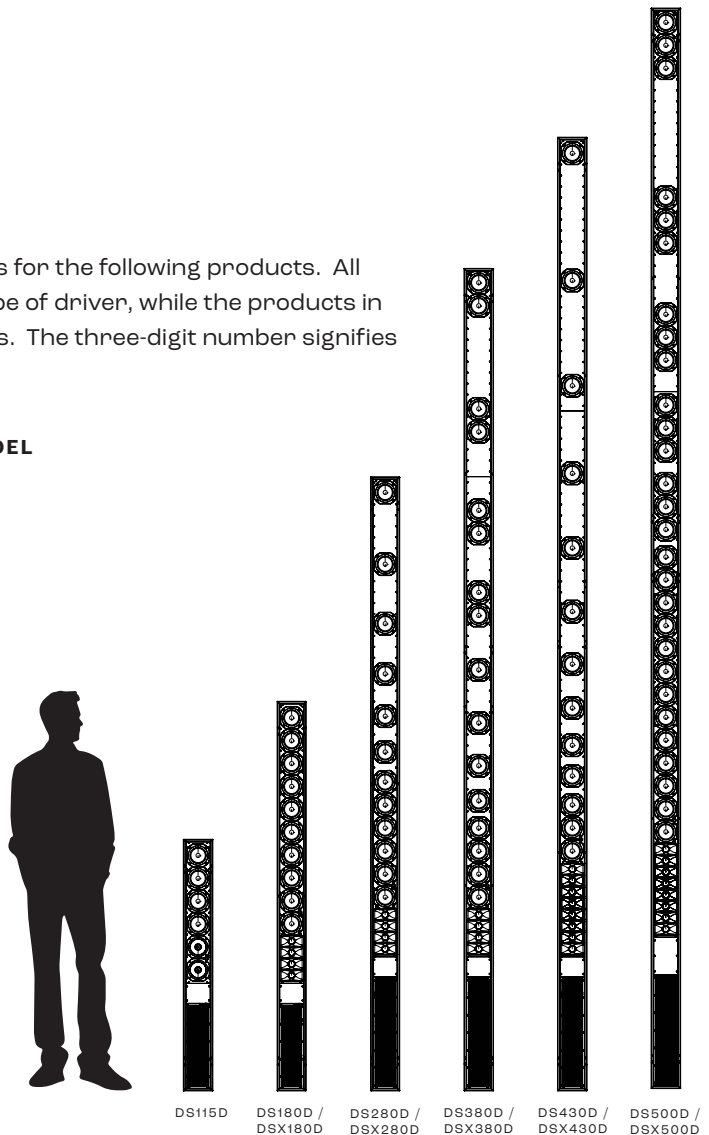

What's in the Packaging

In addition to the loudspeaker itself each loudspeaker ships with the following items (packed separately inside the main packaging):

- Quick start guide
- Accessory Box containing:

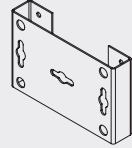
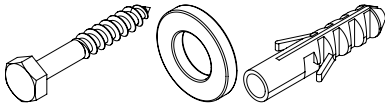
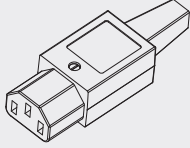
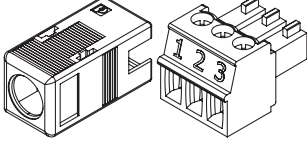
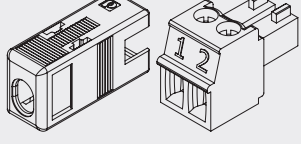
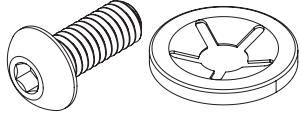
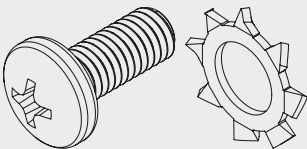
ITEM	QTY	USE	PICTURE
Mounting Brackets	2 or 3*	Speaker mounting	
30 mm hex-head screws with washers and wall plugs	4 or 6*	Mounting bracket fixings, wall	
Female IEC mains connector	1	AC input	
3-pole female Phoenix connector, with cover	1	Mating connector for analog audio	
2-pole female Phoenix connector, with cover	2	Mating connector for fault relay and external fan	
Set of M4 x 10 round-head screws with star retaining washers	4 or 8*	Grille retaining screws	
M5 x 12 pan-head screws with shakeproof washers	8 or 12*	Mounting bracket fixings, loudspeaker	
Caution Label	1	Mains cable label	Intellivox Connector Set Safety Notice <small>Intellivox Connector Set Safety Notice Caution, to reduce the risk of electric shock, grounding of the centre pin of this plug must be maintained. DUR12710609</small> <small>Intellivox Connector Set Safety Notice Caution, to reduce the risk of electric shock, grounding of the centre pin of this plug must be maintained. DUR12710609</small>

*Quantities depend on specific model.

Section 2. Preparing for Installation

Before installing the Intellivox Dante loudspeaker, several points should be considered.

2.1 PHYSICAL INSTALLATION AND DIGITAL DIRECTIVITY ANALYSIS (DDA)

It is assumed that a Digital Directivity Analysis (DDA) has been conducted before installation. DDA is JBL's proprietary simulation and optimization software, used to determine the optimum loudspeaker location for accurate acoustic coverage. The analysis specifies the acoustic center (location and height above finished floor level). Confirm you have this information before starting installation.

- Unless otherwise specified by the system designer, install the Intellivox Dante loudspeaker perpendicular to the listening plane (vertical if the floor is horizontal).
- For horizontal floors, verify that the mounting surface is vertical and that all mounting positions (2 or 3 depending on model) are in the same plane.
- Intellivox Dante units can be ordered with the electronics module at either the top or bottom. This is determined during DDA analysis and cannot be changed after production.

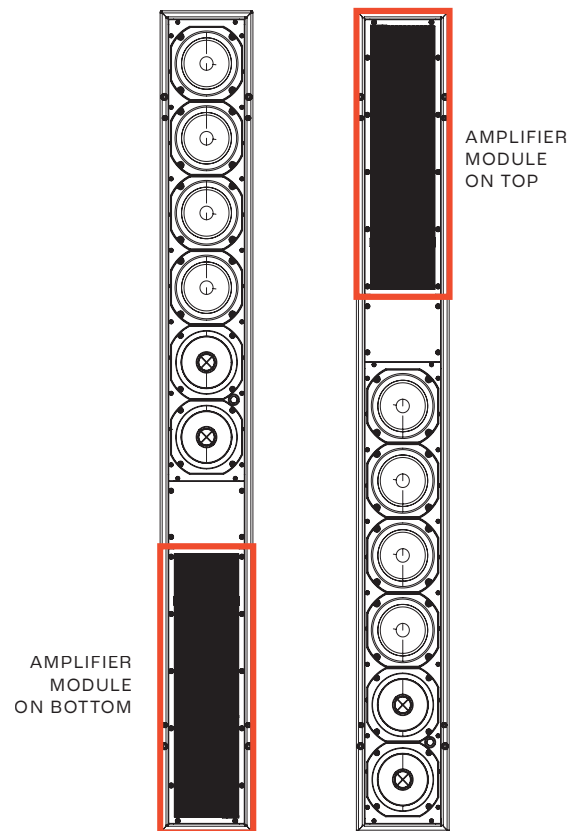

2.2 CONNECTIONS AND PLANNING

Depending on the installation design, some or all of the following connections will need to be provided at the loudspeaker position. In many cases, it is easier to run and terminate cables before mounting the loudspeaker. Connection terminals are accessible from the rear, with additional access via a removable front panel.

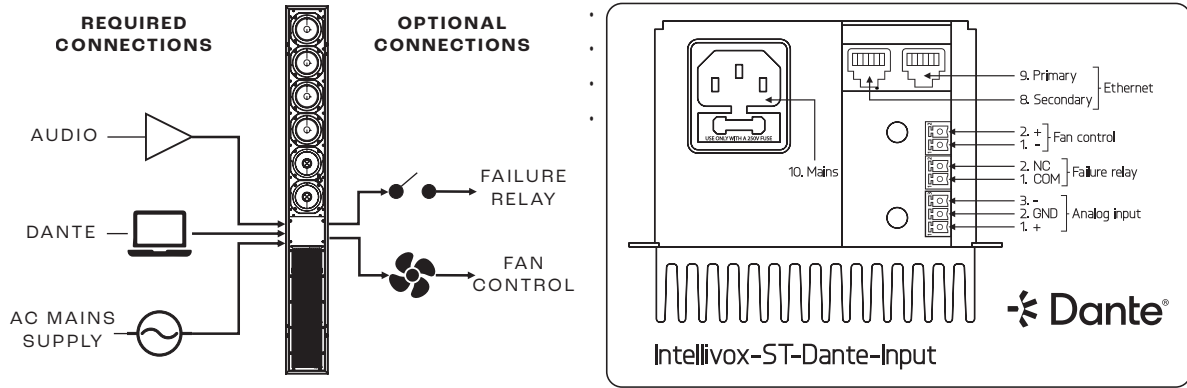

- **Mains Supply:** Operates from 115–230 V AC. Provide a mains outlet near the mounting location, matched to the electronics module position, ensuring it will not affect the specified mounting position. The supply must support full-load power consumption and in-rush current (see product datasheet). Ensure the AC mains connection is wired in accordance with local safety regulations.
- **Network (Dante) connection:** Two network connections provide loudspeaker control (via a PC running WinControl software), remote monitoring, and 8 channels of DANTE I/O. The ports ship configured as switched (for daisy-chaining of loudspeakers) and can be set for redundant operation via the Dante Controller and WinControl software. Once configured, settings are stored locally. The system designer should specify whether a permanent Dante or monitoring connection is required during operation.
- **Analog Audio Input:** Single-channel, balanced line-level input (0 dBV nominal).
- **Fault monitoring:** Provides a simple fault-detect output for installations without network monitoring.
- **Additional cooling:** For ambient temperatures above 40 °C, install an external fan. The Intellivox includes a temperature-controlled fan output for automatic operation.

Section 3. Wiring and Termination

This section contains details about each of the available connections. This includes wiring, termination, and other key details.

3.1 AC MAINS

All Intellivox Dante loudspeakers are equipped with a 3-pin IEC mains connector with integrated fuse holder. You may use a pre-made IEC mains cable if the length and current rating are suitable. Otherwise, use the supplied IEC cable plug with stranded appliance cable, wired to a mains plug. The completed cable must be rated for the voltage and power consumption of the specific Intellivox model and mains outlet. The caution label contained in the Intellivox Dante standard connector set must be placed in close proximity to the IEC female cable plug as indicated.

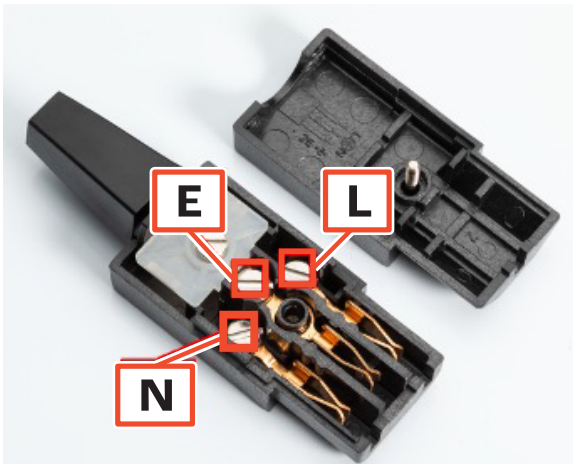

TERMINAL	EURO	USA
L	Brown	Black
E	Green/Yellow	Green
N	Blue	White



WARNING: This Apparatus is a Class I device and must be connected to safety ground.



WARNING: To replace the fuse: unplug the IEC cable, then replace with a fuse of the same type and value.

3.2 NETWORK / DANTE

Intellivox Dante loudspeakers include two ethernet ports for setup, control, monitoring, and Dante I/O. Ethernet ports ship configured as switched (for daisy-chaining of loudspeakers) and can be set for redundant operation via the Dante Controller and WinControl software.

Use a high-quality CAT 5e cable or higher with RJ-45 connectors in straight-thru configuration. The typical maximum cable length for CAT 5e is 100 meters.

For additional information about ethernet standards please see IEEE 802.3 (this includes information about wireless and wired 10Base-T, 100Base-T, and 1000Base-T). For further details about Dante networks visit the Audinate Dante website.

3.3 ANALOG AUDIO INPUT

Each loudspeaker features a 3-way Phoenix connector for the analog audio input (included in the accessory box). The audio source should be a low impedance balanced output. Use a high-quality twisted pair, with a shield cable. Follow the instructions and diagram below for termination.

- Strip 5 mm (about 3/16 inch) of insulation removed to provide for proper connection.
- Insert bare end of the wire and tighten the screws using a small flathead screwdriver.
- Double-check that the wires are not frayed, and that bare wire is not exposed (either of which can lead to shorting between the wires).

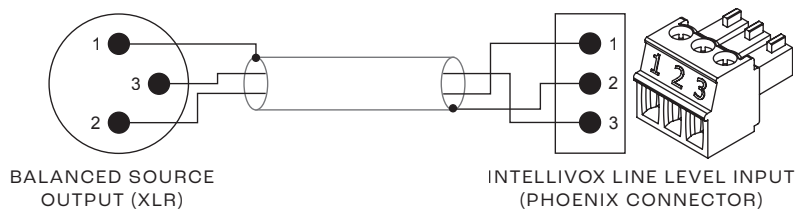

XLR OUTPUT	INTELLIVOX INPUT
Pin 2, + (hot)	Pin 1, + (hot)
Pin 3, - (cold)	Pin 2, SCN/GND
Pin 1, SCN/GND	Pin 3, - (cold)



WARNING: Intellivox Dante DS/DSX models are not capable of 70/100 V input.

3.4 FAULT DETECTION

A 2-way Phoenix connector (included in the accessory box) provides simple fault monitoring. During normal operation the relay is closed; when a fault occurs, the relay opens. The relay contacts support up to 125 mA at 24 V. Follow the instructions and diagrams below for termination.

- Strip 5 mm (about 3/16 inch) of insulation removed to provide for proper connection.
- Insert bare end of the wire and tighten the screws using a small flathead screwdriver.
- Double-check that the wires are not frayed, and that bare wire is not exposed (either of which can lead to shorting between the wires).

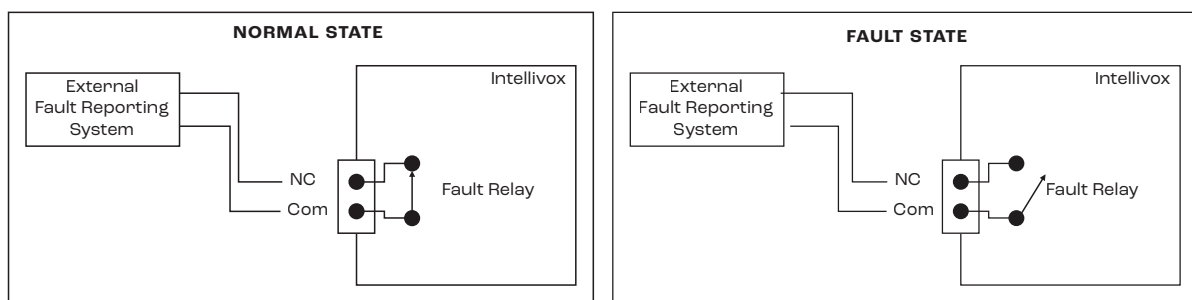

3.5 ACCESSORY FAN CONTROL

A 2-way Phoenix connector is provided for external fan control (included in the accessory box). The output is a PWM signal that adjusts speed based on internal temperature. Use a 24 V DC fan with power consumption below 3 W and a maximum current rating of 125 mA. Follow the instructions and diagrams below for termination.

- 0 Strip 5 mm (about 3/16 inch) of insulation removed to provide for proper connection.
- 0 Insert bare end of the wire and tighten the screws using a small flathead screwdriver.
- 0 Double-check that the wires are not frayed, and that bare wire is not exposed (either of which can lead to shorting between the wires).

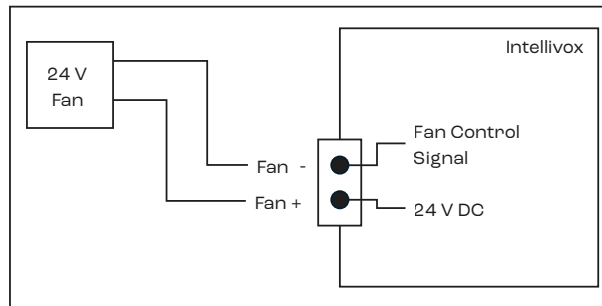

WARNING: DO NOT connect an external relay for a mains-voltage fan.

Section 4. Physical Installation

Mounting an Intellivox Dante loudspeaker is a straightforward procedure, but several critical points should be considered.

4.1 ACOUSTIC CENTER

The loudspeaker's height relative to the floor is critical. The operational height is defined during the acoustic design process and corresponds to the position of the acoustic center. This position is marked with a yellow sticker on the front of the unit when shipped.



Allow for the offset between the acoustic center and the top/bottom of the unit when marking mounting positions. The model-specific specification sheet supplied with each loudspeaker includes a mechanical drawing clearly showing the mounting position locations. Deviation from the specified acoustic mounting height may severely degrade performance.

4.2 MOUNTING OPTIONS

There are three options for mounting the Intellivox Dante loudspeaker:

1. Standard mounting brackets (supplied): For flat walls or curved surfaces (e.g., pillars). Leaves a 25 mm gap between unit and wall.



- 2. Swivel brackets (optional accessory): Allow angling the vertical axis up to 45° or 90°.

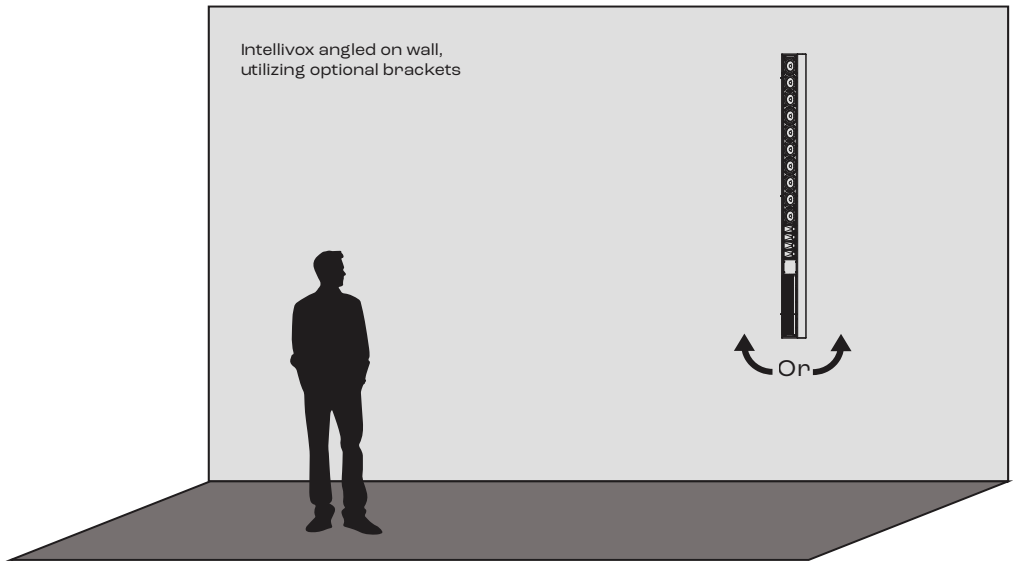

- 3. Recessed mounting: For flush installation in walls or panels. Requires longer M5 screws (thread depth 16 mm).



4.3 MOUNTING PROCEDURE

The general mounting procedure using the standard brackets is described below.

1. Use of the wall plugs and hexagon head screws supplied is recommended. If using other types, ensure that the head diameter does not exceed 11.5 mm (0.45”) and the screw size not larger than 6 mm (0.23”). The drawing below shows details of the standard bracket to ensure the appropriate wall plugs are used.

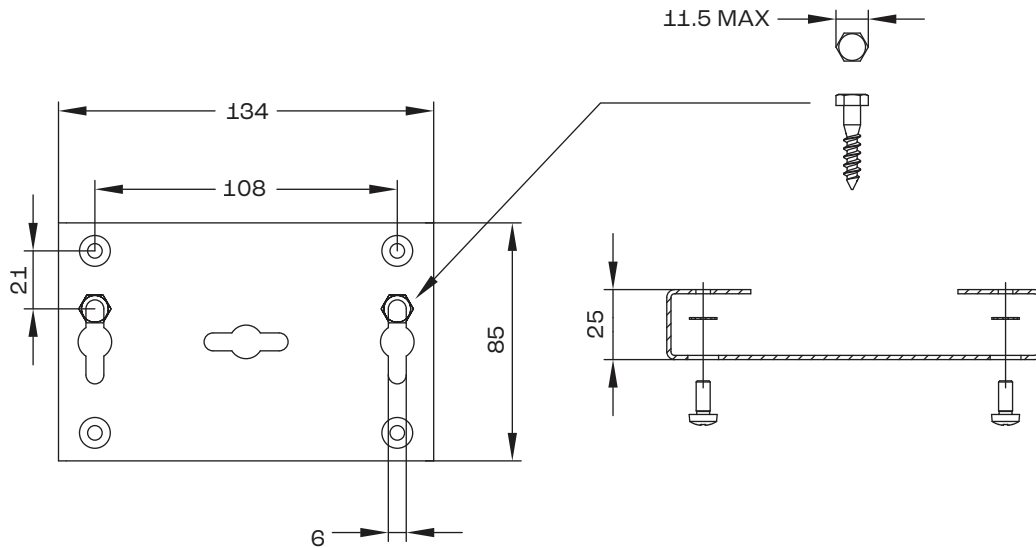

2. Mark and drill the wall plug holes (8 mm) per the specified spacing (found in the models data sheet).

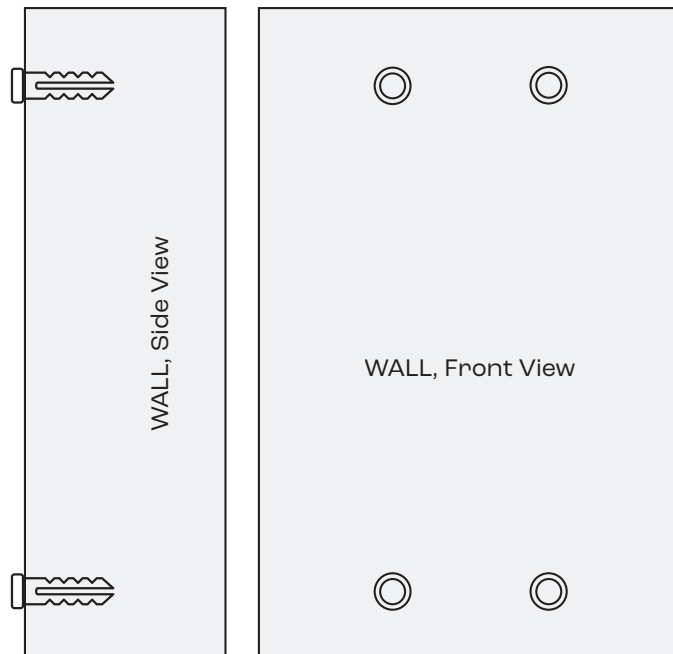

Follow specifications from design process and models data sheet for specific location and spacing of wall anchors.

3. Insert the plugs and screws into the holes. Tighten the screws with a spanner/wrench, but stop with a few mm of screw shaft visible between the head and the wall.

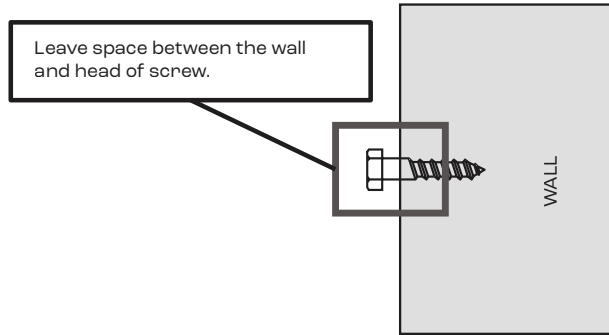

Wall anchor omitted for clarity.

4. Check that it is possible to slide a bracket over the screw heads.

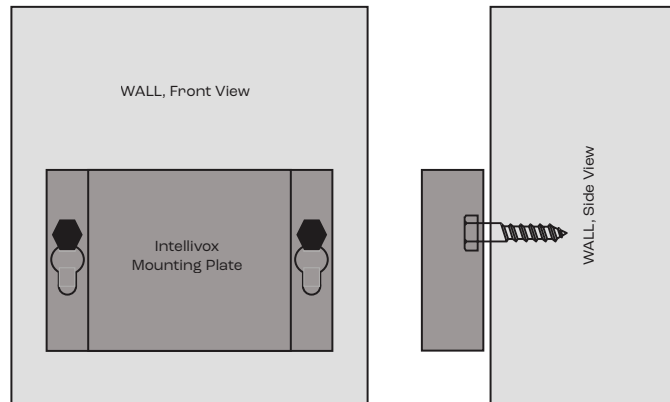

5. Check that the chosen mounting points will position the column to the correct vertical angle specified by the acoustic design (which is usually exactly perpendicular to the listening area). Use spacers on one or more of the brackets if necessary.

Ensure all brackets are on the same plane and at the correct angle.

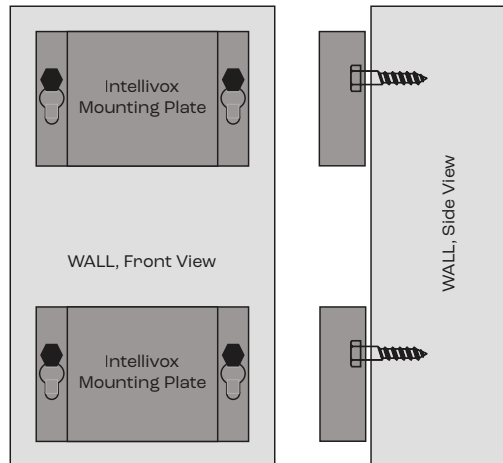

- Using a Philips H2 Screwdriver, attach the brackets to the Intellivox Dante enclosure with the M5 x 12 pan-head screws and shakeproof washers supplied. The 10 mm dia. holes allow screwdriver access to the screw heads.

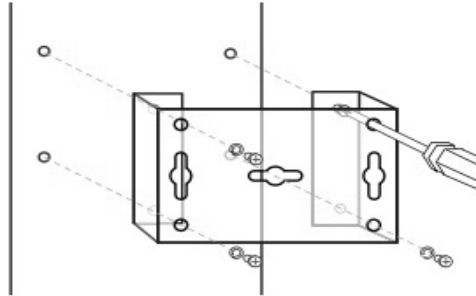

- Lift the Intellivox and slide the brackets over the heads of the hex-head screws protruding from the wall.
- Firmly fasten the screws securing the brackets to the wall. Re-check the verticality (or other angle if specified) with a spirit level or similar levelling device.

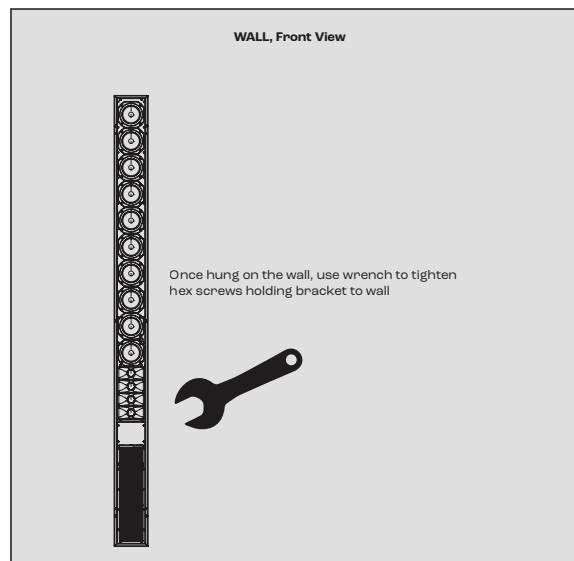

- Remove the front grille(s) from the Intellivox Dante loudspeaker by gently lifting the grille at the locations of the 'snap-on' fittings which hold it in place. Remove the protective foam. Unscrew the four self-tapping screws securing the connector compartment cover and remove the cover. Thread all cabling through the connector compartment from the rear so that it is free and accessible from the front.
- Terminate and plug in all the connectors and replace the connector compartment cover and the grille(s)*.
- Secure grille(s) at each corner with supplied M4 round head screws and star retaining washers.

Section 5. Unit Check and Connecting to Unit

Once the loudspeaker is physically installed, power applied, and connected to a network or computer, use WinControl software to verify operation and upload the settings file. For full details about the use of WinControl please see its user guide.

5.1 PREPARING FOR CONNECTION

Intellivox Dante loudspeakers support combined device control and Dante audio over a single cable. Although WinControl can automatically detect devices, Dante Controller is recommended for routing and verifying network settings.

Ensure the loudspeaker and computer are on the same subnet. If no DHCP server is present, the device defaults to Link Local with IP 169.254.*.* and subnet mask 255.255.0.0. By default, Intellivox Dante Loudspeakers use port 4418. Ensure your network/computer does not block traffic on that port.

5.2 CONNECTING TO THE LOUDSPEAKER

1. Apply power to the loudspeaker and allow 1 to 2 minutes for the loudspeaker to obtain an IP address.
2. Launch WinControl from your computer.
3. Open **Options > Communication options** and confirm the **off-line** box is unchecked and the **AXYS serial bridge** is selected as the hardware. Use the IP and port dropdown to select the Intellivox Dante unit you wish to control. After making selections, click the **Apply** and **Ok** buttons for the changes to take effect and exit the dialogue box.

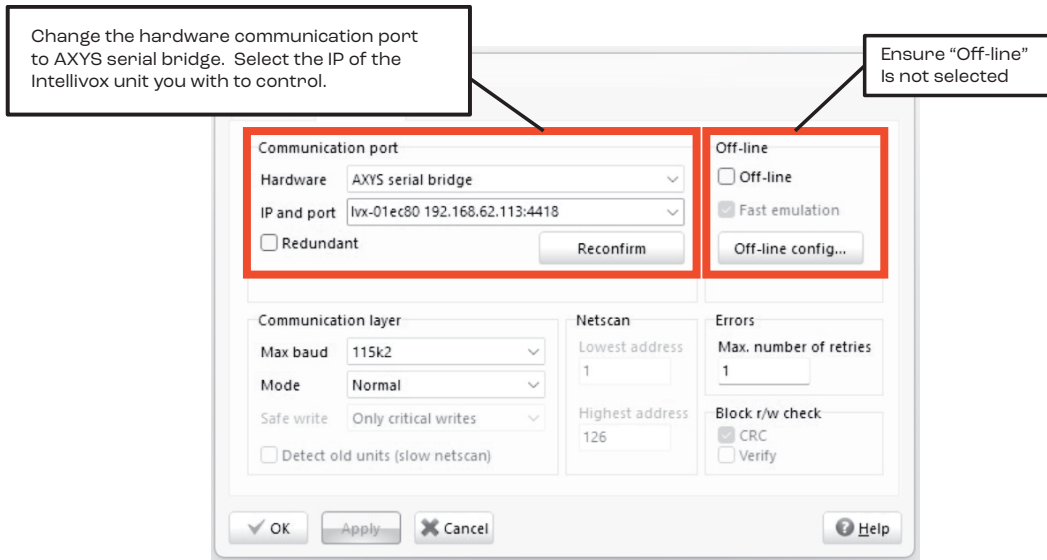

- If the PC is connected to only one Intellivox Dante unit, the screen should look similar to the image below. The green rectangle on the main page represents the Intellivox Dante loudspeaker. The model number is shown below and the units network address shown to the right. (For a network with multiple units see section 5.3 for instructions.)

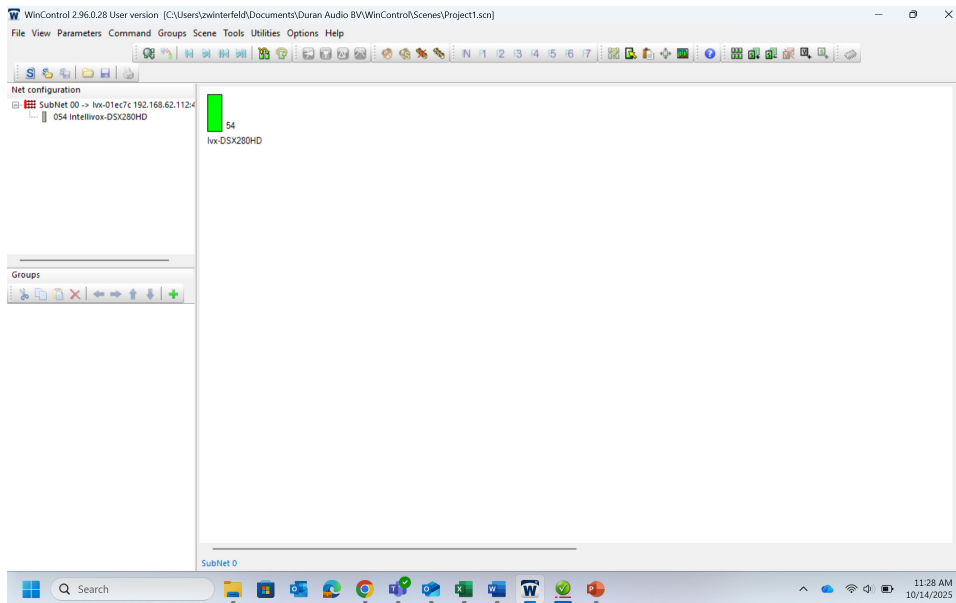

- If the WinControl software does not show any Intellivox Dante units, click on **Command > Netscan** to force the PC to re-scan the network. If the rescan fails to see units please check all network connections, and the correct port on the PC is selected (see step 3).

5.3 CONNECTING TO MULTIPLE UNITS

- Apply power to the loudspeakers and allow 1 to 2 minutes for the loudspeakers to obtain IP addresses.
- Launch WinControl from your computer.
- To connect to multiple units, click on **Options > Main Options** to bring up the Main options dialogue box. Under the Net tab, increase the number of local subnets to match the number of units you wish to connect to. After making selections, click the **Apply** and **Ok** buttons for the changes to take effect and exit the dialogue box.

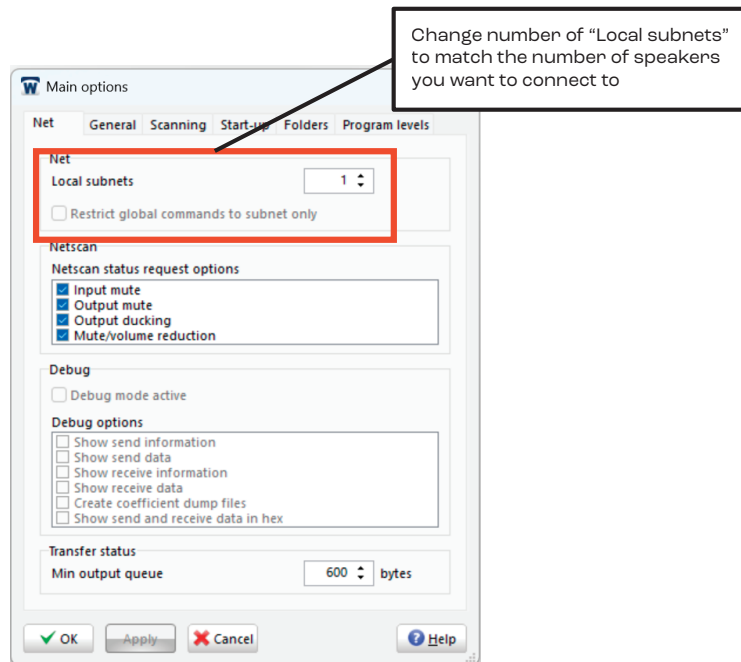

- After selecting the number of subnets, open **Options > Communication options** to configure. Each subnet tab will connect to a different unit and will need to be configured separately. For each unit confirm the **off-line** box is unchecked and the **AXYS serial bridge** is selected as the hardware. Use the IP and port dropdown to select the Intellivox unit you wish to control. After making selections, click the **Apply** and **Ok** buttons for the changes to take effect and exit the dialogue box.

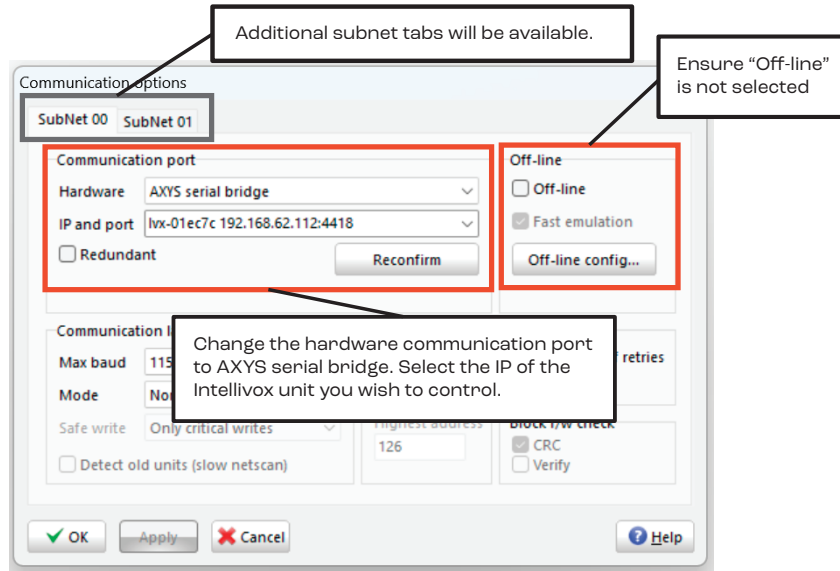

- Multiple units should now appear on the main page. The green rectangles in the main page represents the Intellivox Dante loudspeakers. The model number is shown below and the units network address shown to the right.

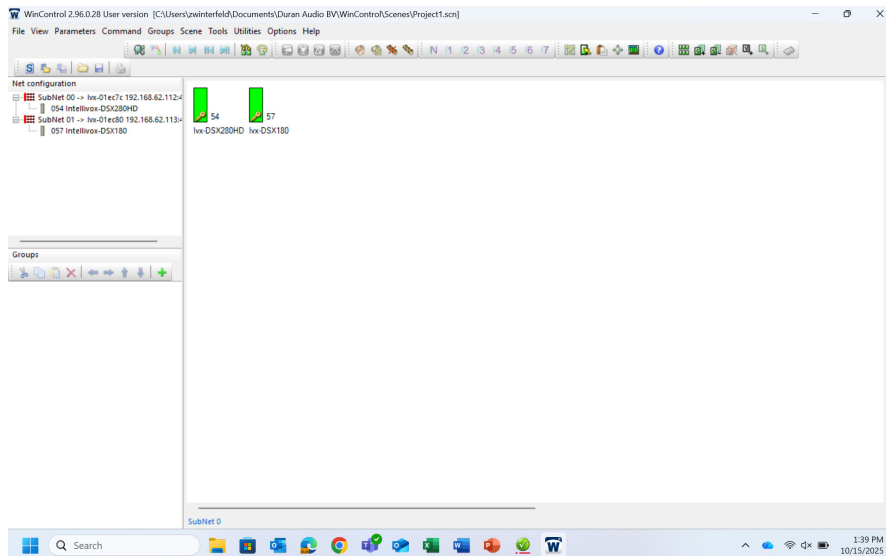

- If the WinControl software does not show any Intellivox units, click on **Command > Netscan** to force the PC to re-scan the network. If the rescan fails to see units please check all network connections, and the correct port on the PC is selected (see step 3).

5.4 DANTE REDUNDANT OPERATION

The following directions detail how to change the Dante mode from switched to redundant.

1. Open **Dante Controller** software.
2. Open the **Configure Dante Interfaces** window and ensure the primary interface is connected to the Dante primary network and the secondary interface is connected to the Dante secondary network. Once configured, click the **Ok** button to close the window.

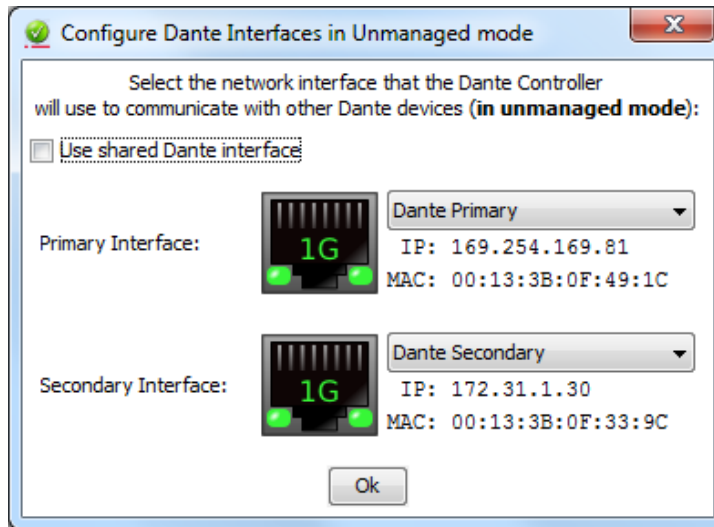

3. Open the **Device View** window for the Intellivox Dante unit you wish to control. Under the **Network Config** tab, use the drop-down menu to change from **switched** (default) to **redundant**. The device will need to be power cycled for the change to take place.

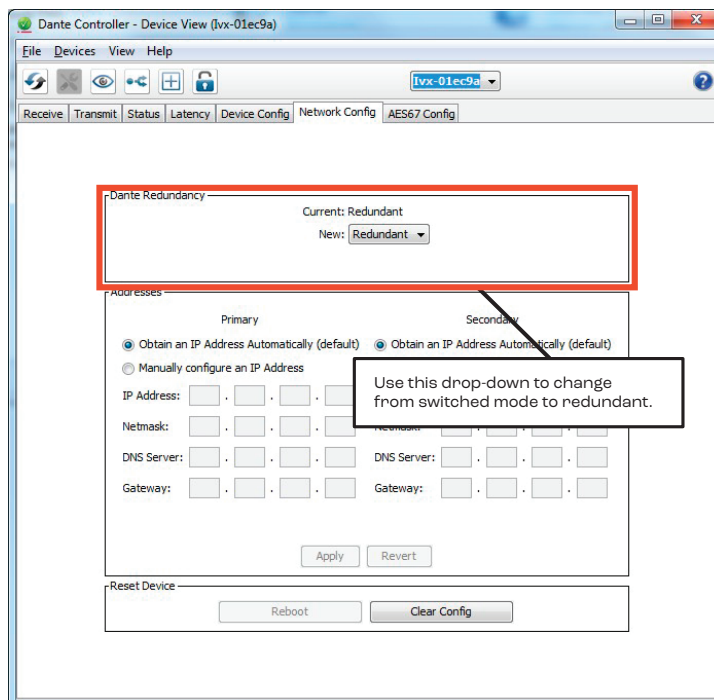

- After rebooting the Dante Controller software should show the IP address for both the primary and secondary Dante interface.

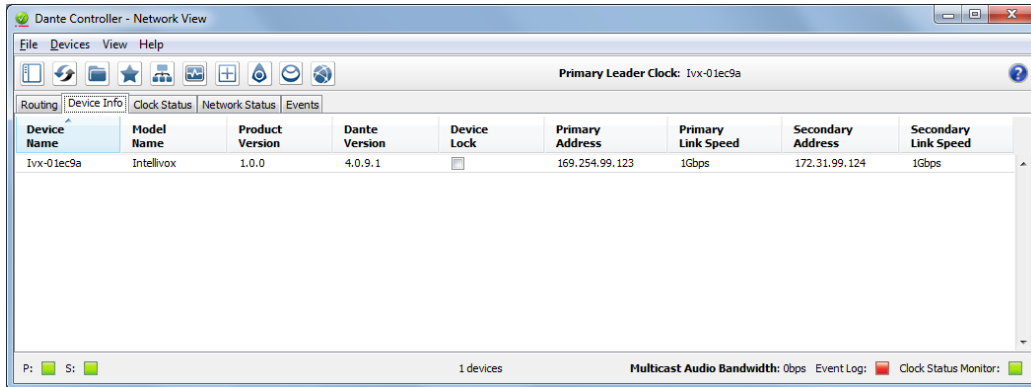

- Launch WinControl from your computer.
- Open **Options > Communication options** and confirm the **off-line** box is unchecked and the **AXYS serial bridge** is selected as the hardware. Ensure the **redundant** box is selected and use the IP and port dropdown to select the primary port of the Intellivox Dante unit you wish to control. After making selections, click the **Apply** and **Ok** buttons for the changes to take effect and exit the dialog box.

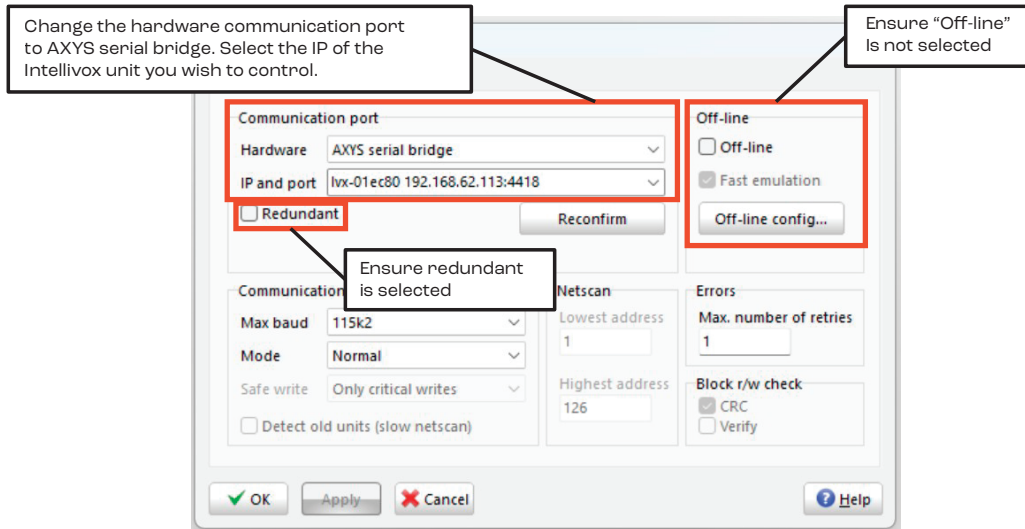

- If the PC is connected to only one Intellivox Dante unit, the screen should look similar to the image below. The green rectangle in the main page represents the Intellivox Dante loudspeaker. The model number is shown below and the units network address shown to the right.

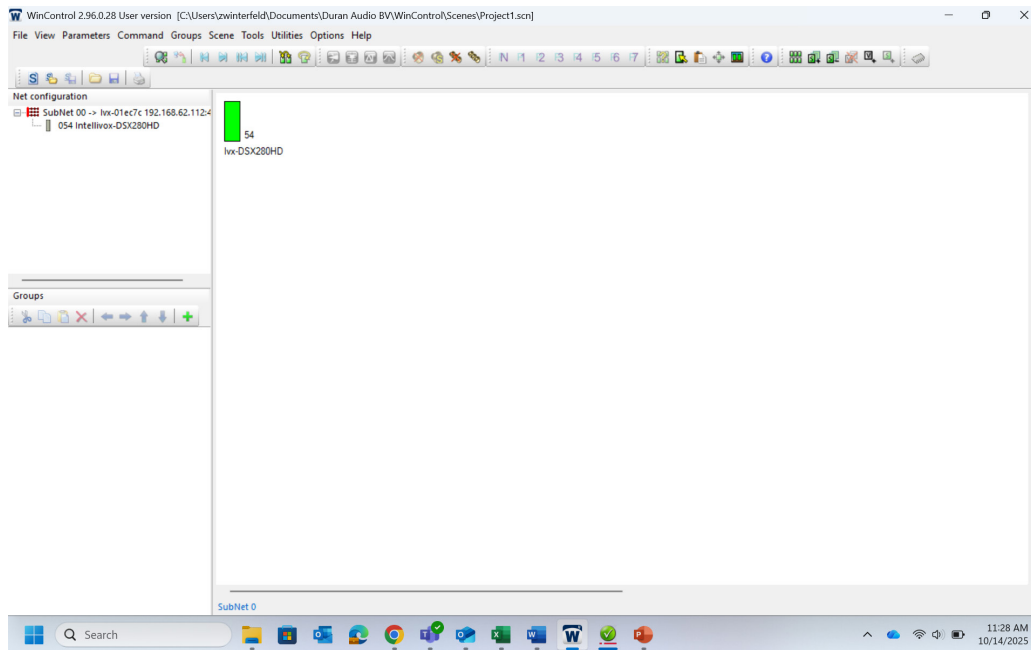

- If the WinControl software does not show any Intellivox Dante units, click on **Command > Netscan** to force the PC to re-scan the network. If the rescan fails to see units please check all network connections, and the correct port on the PC is selected (see step 6).

5.5 UPLOADING SETTINGS TO THE LOUDSPEAKER

- Select the Intellivox Dante you want to control by clicking once so its model number and IP address are highlighted.
- Click **File > Load Settings** to open the two dialogue boxes shown below.

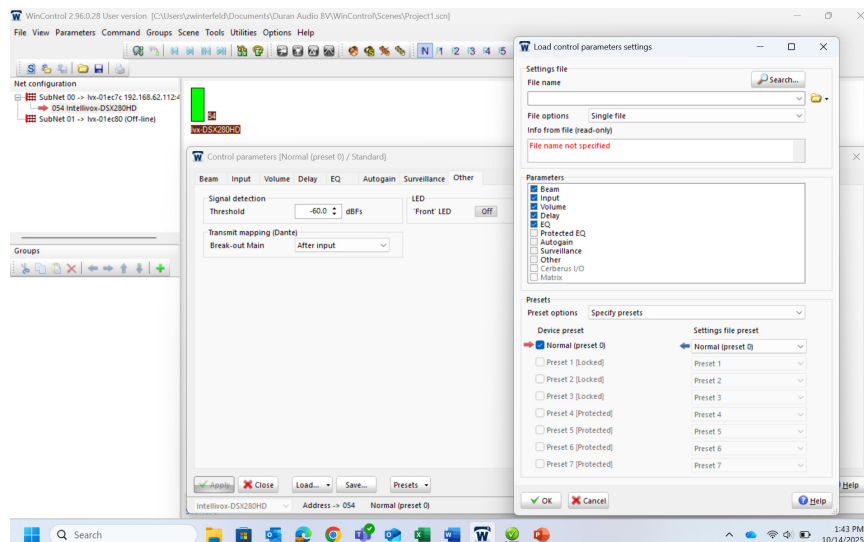

- At the top of the **Load control parameters settings** window there is a **File name** box. To upload a previously created file, click the **Browse** button (to the right of the File name field), which will open a dialogue box where the appropriate Intellivox Dante settings file can be selected. These files will always have a .ini file extension. After selecting the correct settings file, click **Open**, and the dialogue box will close.

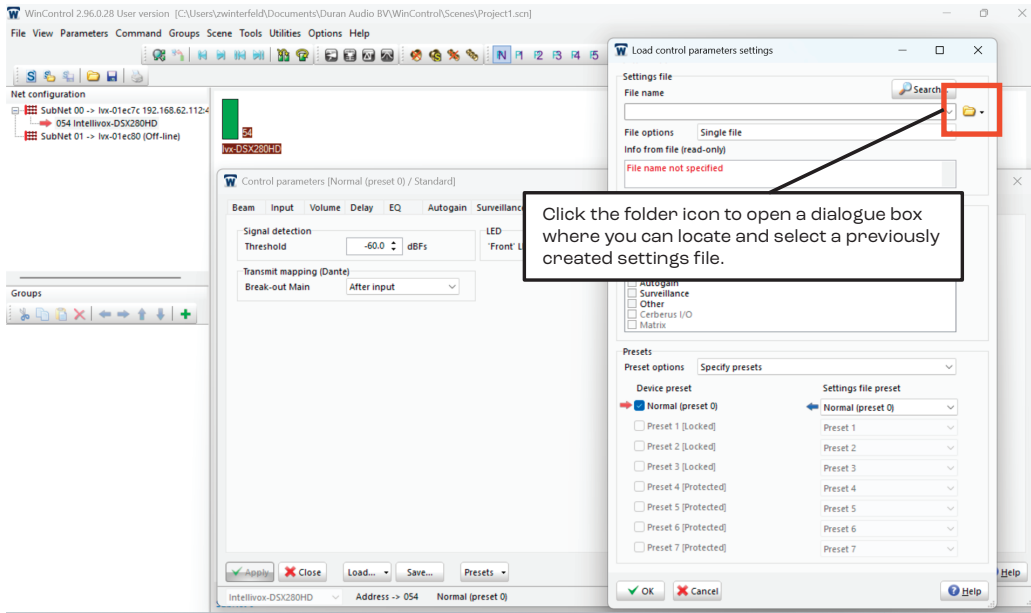

- After selecting the correct file, ensure the proper parameter groups are selected and specify which preset should be used. Select **Ok**.

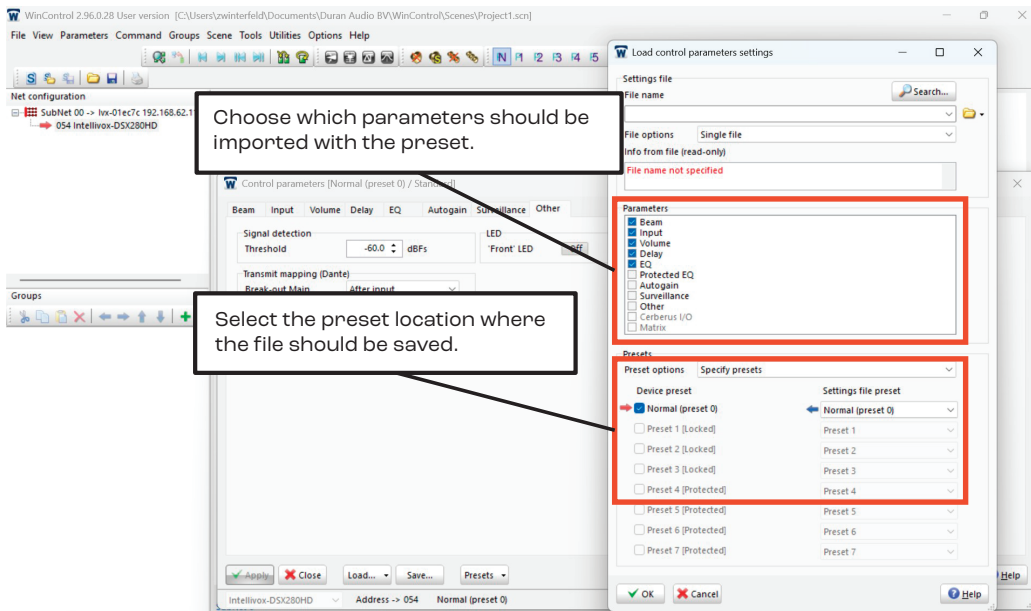

- An additional info dialogue box will open. Click **Ok** to start the upload process.

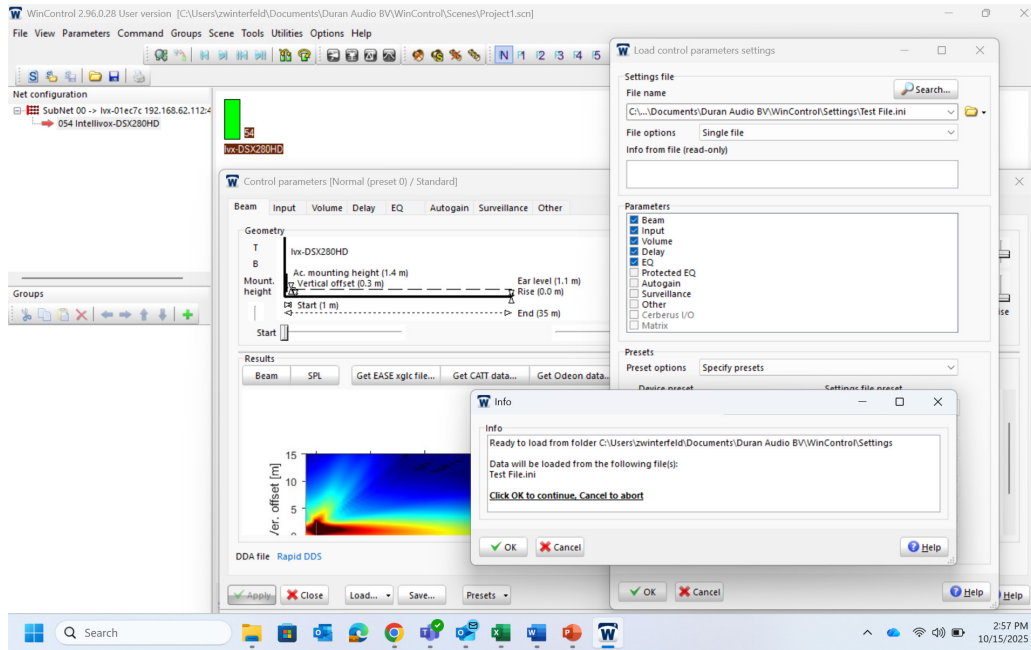

- The Control parameters box can now be closed and the upload is complete.
- Use this procedure for each loudspeaker on the network. To upload settings to several Intellivox Dante loudspeakers simultaneously see *Addresses and Groups* in the WinControl help file.

Section 6. Appendix

6.1 OPTIONAL ACCESSORIES

Listed below are a number of additional components which may be required for an individual installation.

DESCRIPTION	ORDER SKU
Intellivox wall bracket 25mm, 2 pcs includes fasteners	IVX-802225 (RAL9010) IVX-802227 (RAL9007)
Intellivox wall bracket 25mm, 3 pcs includes fasteners	IVX-802226 (RAL9010)
Intellivox hinge bracket 90°	IVX-802000 (RAL9010)
Intellivox swivel bracket 90°	IVX-806608 (RAL9010) IVX-806668 (RAL9007)
Intellivox swivel bracket 45°	IVX-806618 (RAL9010)
Cable cover plate, 2 x PG13.5, includes fasteners	IVX-802110 (RAL9010)

6.2 SOFTWARE AND FIRMWARE UPDATES

The WinControl application is freely available and can be downloaded from <http://www.jblpro.com>. Installers, users, and engineers should regularly check for updates. Intellivox firmware and DSP software upgrades will also be made available through the website.

For further information about how to use WinControl please refer to the WinControl Help files.