



Technical Notes Volume 1, Number 23

JBL's HLA™ Series Loudspeaker Systems and DCD™ Transducers

Introduction:

HLA stands for horn loaded array and is JBL's name for a revolutionary new series of loudspeaker systems intended for the highest quality tour sound applications. DCD stands for dual coil drive and refers to a completely new magnet/voice coil topology for cone transducers that results in more efficient use of both steel and magnetic material, enabling us to reduce the transducer weight to about one-third that of traditional designs. Other characteristics of these transducers are their high linearity, excellent heat dissipation, and adaptability to driving horn loads.

The basic HLA system is a three-way horn loaded array that makes good use of the light-weight transducers developed for it. Arrayability is the key word. These components are mounted in an aluminum SpaceFrame™, and through an ingenious system of

Figure 1. HLA array for medium size venue (flat front)

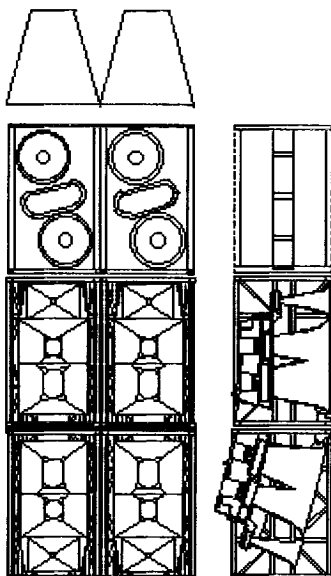

interlocking parts, the MultiBand Waveguide™ can be tilted up or down as required — without the need for altering the basic rigging. It is the small size and weight of the transducers that makes this possible. A unique dual 460-mm (18 in) subwoofer system complements the 3-way horn array.

In this Technical Note we will discuss the new transducer topology in detail inasmuch as it is central to the HLA system design. We will then present details and performance data on the total system.

Basic System Concept:

We will begin with an overview of the basic system concept. Figure 1 shows a typical array for a medium size venue with the systems adjusted for 40° horizontal and 45° vertical coverage. Note that the basic 3-way horn/waveguide assembly in the model 4895 can

Figure 2. HLA array for medium size venue (curved front)

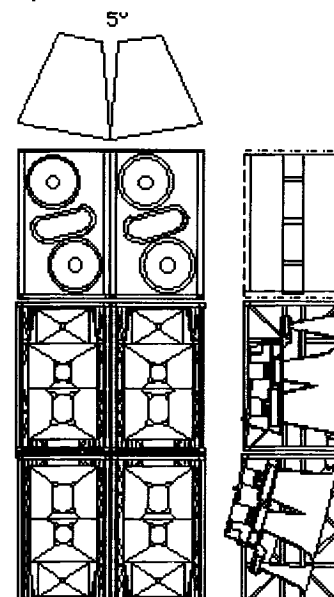

be tilted 15° as a unit while the SpaceFrame remains fixed. For wider coverage the two vertical stacks may be splayed outward as shown in Figure 2. The goal is to use a minimum number of high intensity, highly directive sources so that each listener hears a minimum number of effective sources, with a resultant high direct-to-reverberant ratio.

The model 4897 subwoofer part of the system is not horn loaded and makes use of two 460 mm (18 in) diameter cone transducers in an optimized enclosure.

The MultiBand Waveguide with attached magazine is clearly seen in Figures 1 and 2. All three horn sections are of Optimized Aperture™ design. The high-frequency horn (shown at the top of the middle module) is driven by the model 2451SL, which was discussed in detail in Technical Note Volume 1, Numbers 21. This portion of the system covers the frequency range from 1140 Hz to 16 kHz.

The lower and upper-midrange parts of the spectrum are covered by waveguides that span the frequency ranges from 100 to 280 Hz and 280 Hz to 1140 Hz. As a group, the three horns comprise a MultiBand Waveguide. Key elements in the performance of the two midrange horns are the new cone transducers designed specifically for horn application. These are known as DCD, Direct Cooled, Differential Drive transducers, and we will now describe them in detail.

The DCD Transducers:

Anatomy of a DCD transducer:

Figure 3 shows a section view of a standard JBL magnet-voice coil assembly at the left and an equivalent DCD version of it at the right. We use the term "equivalent" in that this comparison of both motors will have the same electrical-to-mechanical power coupling coefficient, $(Bl)^2/R_E$, and also the same moving mass. We are analyzing the two structures "in parallel," so to speak, in order to clarify the differences between them.

In the standard design, magnetic flux B crosses the gap in which a coil of wire of length l is placed. The

Figure 3. Comparison of standard and DCD technology

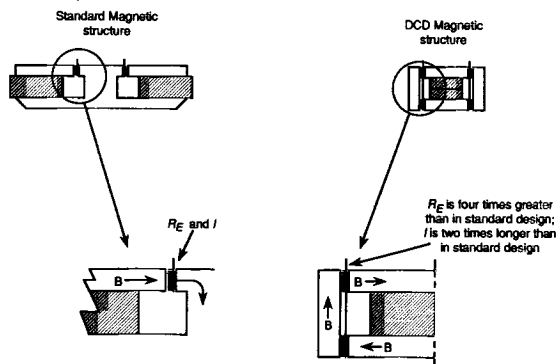

coil has an electrical resistance, R_E . These quantities establish the value of $(Bl)^2/R_E$.

Next, we move to the DCD topology, as shown at the right in Figure 3. In this design there are two magnetic gaps that have opposite flux. Two voice coils are used, and they are connected in reverse so that the mechanical forces they produce will add (be in phase). For the moving mass to remain the same, the voice coil winding must have the same height and half the width as in the standard case. The value of B will be kept the same.

When these changes are made, the total length (l) of the voice coil will be doubled and the resistance per-unit length of wire will be doubled, since the cross-sectional area has been halved. The total resistance of both voice coils in series will then be four times what it was in the standard case. Since $(Bl)^2$ will have quadrupled (remember that l has doubled), the new value of $(Bl)^2/R_E$ will be $(B2l)^2/4R_E$. This is equal to $4(Bl)^2/4R_E$, which of course reduces directly to $(Bl)^2/R_E$.

In terms of electrical-to-mechanical coupling the two approaches are identical; but in other areas we have gained a great deal:

1. The new voice coil assembly now has twice the surface area of the old one. This means that it will have twice the heat dissipation of the old coil, which translates directly into twice the power input capability for a given operating temperature and observed amount of dynamic compression.

2. The new voice coil structure will have less effective inductance than the standard one, since the reversely wound coils will have negative mutual inductance between them. This translates into a flatter impedance curve at higher frequencies, producing more acoustical output for a given drive signal.

3. The compact nature of the DCD magnet structure requires much less iron in the magnetic return path. As a result, a DCD transducer can weigh as little as one-third the equivalent standard design. This advantage shows up primarily in overall system weight and ease of installation and adjustment.

Other design features in the DCD transducers include:

1. The small overall magnet structure can be conveniently nested in a large heat sink for efficient dissipation of heat from the coils, as can be seen in Figure 4.

2. The heatsink fins protrude outside the magazine in which the transducers are mounted. The fins are shaped in such a way that they provide optimum cooling via airflow through the heatsinks. In addition, the lower-midrange driver has vented gap cooling.

Transducer linearity:

The neodymium magnet material used in the DCD transducers is much less prone to flux modulation

Figure 4. Section view of JBL 2251H transducer

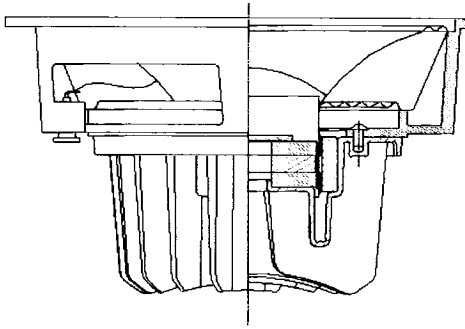

than ferrite materials. As a result, the flux shorting ring, an essential part of JBL's Symmetrical Field Geometry™, is not necessary with neodymium structures. Figure 5 shows the second quadrant performance of the B-H curves for typical neodymium and ferrite magnet materials. We can see that a typical operating point for the neodymium magnet is much higher along the B-axis than that of a ferrite magnet. Therefore, for a given change in magnetizing force produced by signal current in the voice coil, the resulting change in induced flux ($\Delta B/B_n$) will be fairly small. By contrast, the resulting change in induced flux for the ferrite magnet will be $\Delta B/B_f$. Since B_n is less than B_f , the total variation in induced flux will be greater with the ferrite magnet. There is about a three-to-one ratio between the amount of flux modulation of the two magnet materials, corresponding to an approximate 10 dB advantage for neodymium over ferrite at any operating level.

Figure 5. Flux modulation in ferrite and neodymium magnet structures

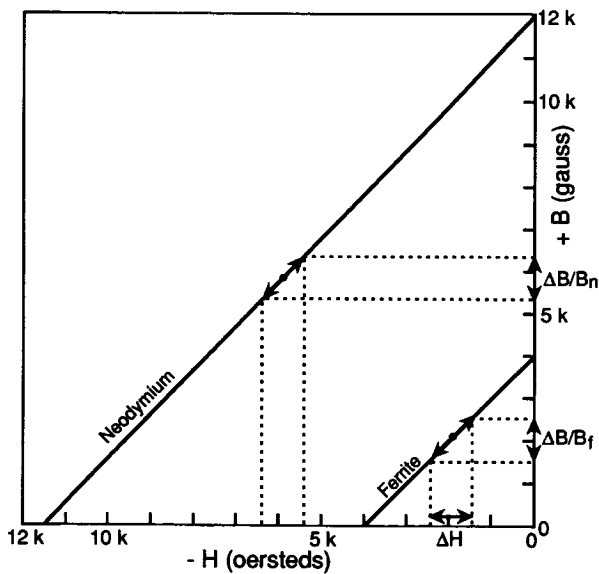
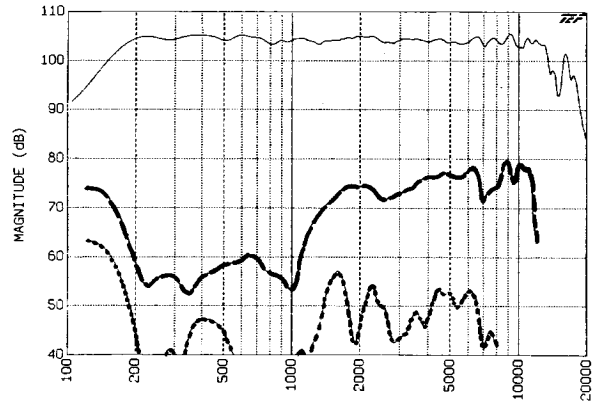

Figure 6 shows the on-axis response and 2nd and 3rd harmonic distortion for the 4895 three-way waveguide array. The nominal power input to the lower and upper-midrange sections is 10 watts, while the matching power required for the HF section would be about

1 watt, due to the higher sensitivity of the HF section. This corresponds to a 1 watt, 1 meter output of 116 dB. Note that the 2nd harmonic distortion in the range from 300 Hz to about 1 kHz is well below 1%, rising to about 3% in the range above about 1600 Hz. Third harmonic distortion is well below 1% throughout the range.

Figure 6. HLA 4895, distortion at 10 watts (dashed curve 2nd harmonic; dotted curve 3rd harmonic)



Finally, we want to point out the extremely flat on-axis response of the 4895 system. This illustrates the inherent linearity and smooth response of the MultiBand Waveguide, augmented by the capability of the JBL DSC 280 controller in fine-tuning and time aligning of complex systems.

Driver optimization for LF horn application:

Our founder, James B. Lansing, knew the importance of light weight moving systems and high magnet strength in designing cone transducers for the large theater horn systems he develop during the thirties and forties. Many years later, Keele (1977) analyzed the application of cone transducers with bass horns and arrived at the graphical data shown in Figure 7. Keele Thiele-Small parameters to define the useful range of the transducer as a low frequency horn driver. The range of flat power response for a cone trans-

Figure 7. Keele's data on driver parameters for LF horn application

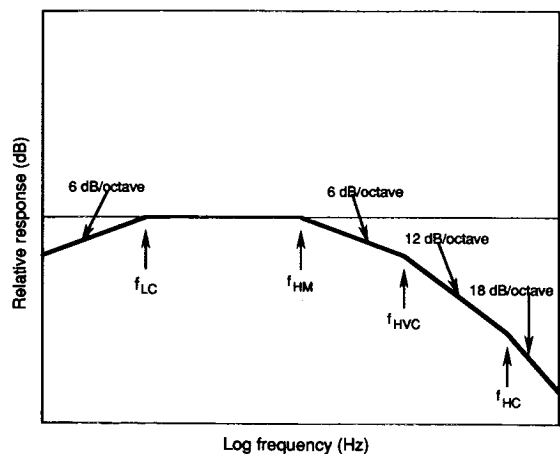

ducer in this application generally extends up to f_{HM} , which is given by:

$$f_{HM} = 2f_s/Q_{ts}$$

Generally, low frequency performance of the driver/horn is basically dependent on horn parameters. High frequency response is driver related, and the primary roll-off is caused by the driver's mass breakpoint, f_{HM} . The mass breakpoint for the 2254 355 mm (14 in) DCD transducer is 560 Hz, an octave above the 280 Hz upper crossover frequency.

As we move higher in frequency, the mass breakpoints cannot always extend to the limit of the intended bandpass. The mass breakpoint for the JBL 2251 250 mm (10 in) DCD transducer is calculated to be 610 Hz, about an octave below the intended crossover frequency of 1200 Hz. However, the crossover frequency between the upper-midrange and HF portions of the HLA system is 1140 Hz, so the natural rolloff of the driver adds directly to the electrical rolloff in the dividing network (see Figure 15) to achieve the ideal value at crossover.

With HF compression drivers, as noted in JBL Technical Notes Volume 1, Numbers 8 and 11, the mass breakpoint, which is normally in the 3500 Hz range, may be one-third to one-fourth of the desired upper frequency limit, thus requiring up to 9 or 12 dB of electrical equalization at high frequencies in order to maintain flat power response.

Keele shows an additional inflection point, f_{HL} , which is caused by voice coil inductance and is given by:

$$f_{HL} = R_e/\pi L_e$$

In the case of the upper mid-frequency DCD model 2251, which is already performing up to an octave above its mass breakpoint, we wanted to minimize the effects of any amount, however small, of voice coil inductance. A drawn copper sleeve was placed over the pole tip magnet assembly. Acting like a shorted secondary turn in a transformer, it effectively swamps out the effect of voice coil inductance, making the high frequency impedance of the transducer virtually resistive. The result is extended HF performance approaching the theoretical limit.

Performance of the Subwoofer System:

The model 4897 subwoofer uses two model 2242H SVG™ transducers in an enclosure made of a trapezoidal tubular frame integrated with a carbon fiber/honeycomb composite material. The result of this is an increase in rigidity and a significant reduction in weight. The porting of the LF system is by way of a large area aperture, contoured at each end, that virtually eliminates turbulence at the highest drive levels, allowing the LF system to deliver full output at enclosure resonance with minimum port compression. Since vent and enclosure losses have been significantly reduced, the system Q has been raised an order of magnitude, resulting in about 3 dB more output than the same pair of transducers exhibit in a conventional enclosure. The data shown in Figure 8 indicates the improvement in LF headroom produced by the reduction in port turbulence. In this figure, port output level at 25 Hz is plotted as a function of relative input power level using standard porting as well as the "radiused" porting afforded by the Linear Dynamics Aperture™ vent design. Note that there is an 8-dB

Figure 8. Port Compression: Linear Dynamics Aperture versus standard porting.

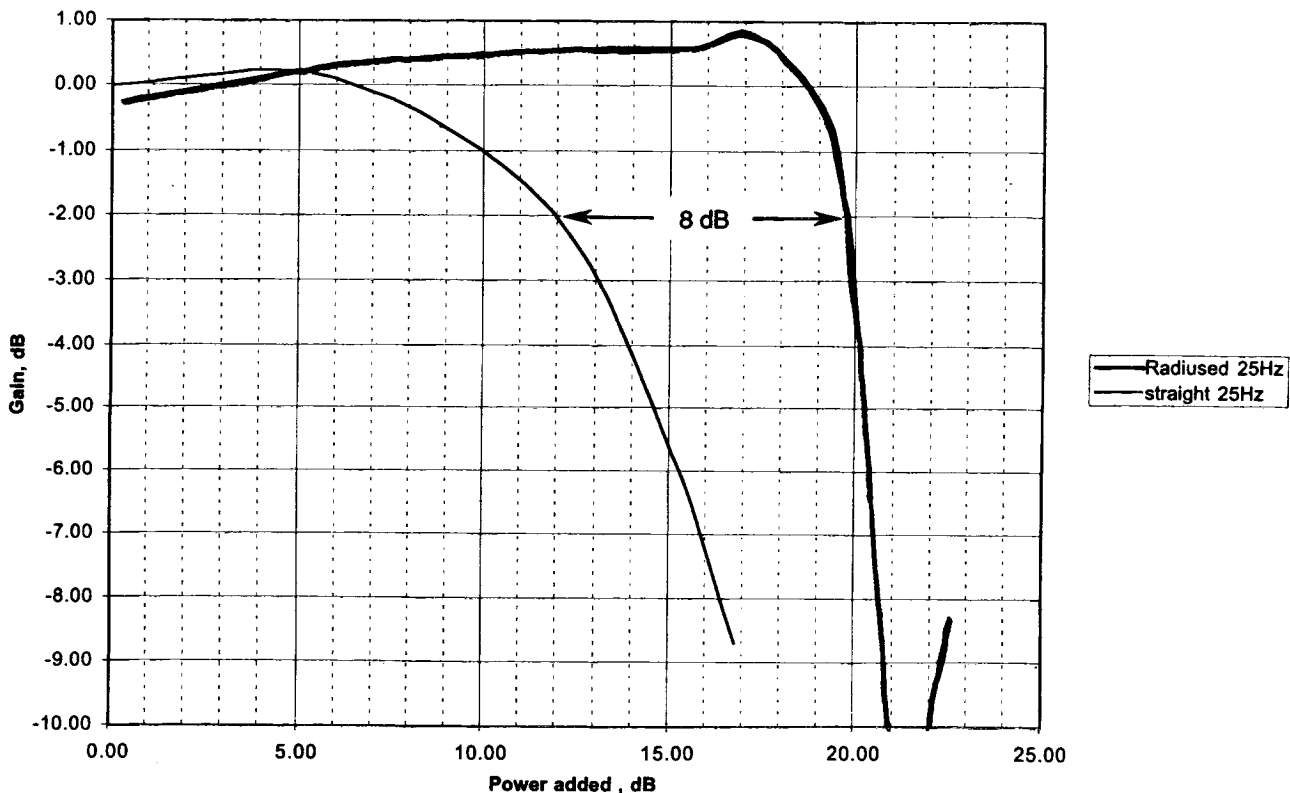

improvement in output level over standard porting at the point where both porting systems exhibit 2 dB of compression.

The 1-watt, 1-meter output and impedance modulus of the LF system are shown in Figure 9, and the one-tenth power (160 watts) output and distortion (second and third harmonics raised 20 dB) are shown in Figure 10. When used in multiples, the effective LF alignment of the ensemble will change, producing a 3-dB rise in very low frequency relative response with each doubling of units.

Directional Performance of the HLA System:

The data shown in Figures 11, 12, and 13 show respectively the -6-dB beamwidth, directivity index (DI) and Q, and the off-axis response of the 4895 system. The horizontal beamwidth narrows uniformly from 125 Hz to 10 kHz. The vertical beamwidth shows only slight inflections in the vicinity of the crossover frequencies, but is otherwise quite uniform in its pattern narrowing over the same frequency range. The horizontal coverage is 40° from 1 to 16 kHz, while the vertical coverage is 30° over the same frequency range. This indicates that coverage of multiple units, splayed both horizontally and vertically will be uniform.

The DSC 280 Digital Controller:

The JBL DSC 280 digital controller is an integral element in the HLA system concept. Multiple system files are stored in the DSC 280, which take into account the number of array elements and the interaction among them at long wavelengths. As an example of the degree of control, Figure 14 shows the electrical

drive curves for a 2x1 array configuration. Individual acoustical contributions of the three sections of the waveguide are shown in Figure 15, and overall acoustical amplitude and phase response of the system is shown in Figure 16.

References:

1. J. Eargle and W. Gelow, "Performance of Horn Systems, Low-Frequency Cut-off, Pattern Control, and Distortion Trade-offs," presented at the Audio Engineering Society Convention, Low Angeles, November 1996; preprint number 4330.
2. M. Gander and J. Eargle, "Measurement and Estimation of Large Loudspeaker Array Performance," *J. Audio Engineering Society*, volume 38, number 4 (1990).
3. D. B. Keele, "Low Frequency Horn Design Using Thiele-Small Driver Parameters," presented at the Audio Engineering Society Convention, Los Angeles, May 1977; preprint number 1250.
4. JBL Technical Note, Volume 1, Number 8 "Characteristics of High-Frequency Compression Drivers."
5. JBL Technical Note, Volume 1, Number 11 "Controlled Power Response: Its Importance in Sound Reinforcement System Design."
6. JBL Technical Note, Volume 1, Number 21 "JBL's New Optimized Aperture™ Horns and Low Distortion Drivers."
7. JBL Technical Note, Volume 1, Number 22 "JBL's New Super Vented Gap™ Maximum Output Low Frequency Transducers."

Figure 9. On-axis response (one watt, one meter) and impedance for 4897

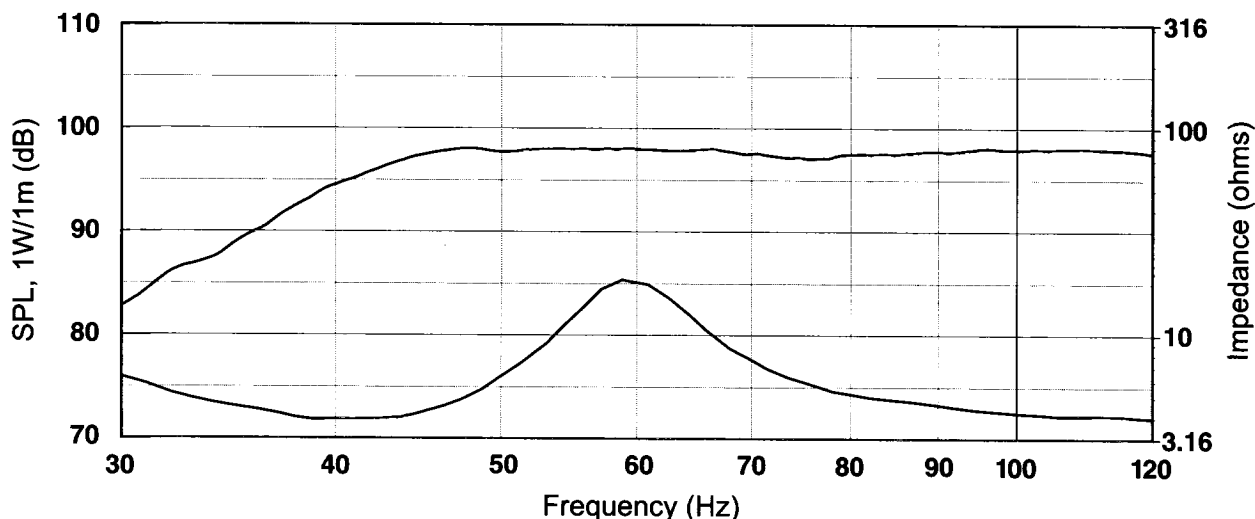

Figure 10. Distortion at one-tenth rated power, 4897

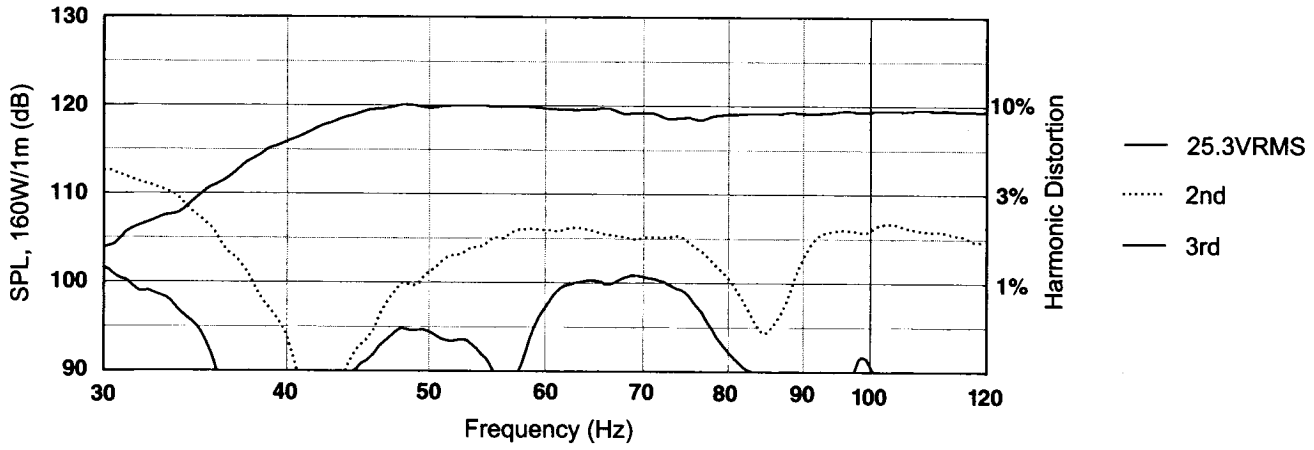

Figure 11. -6-dB beamwidth, 4895

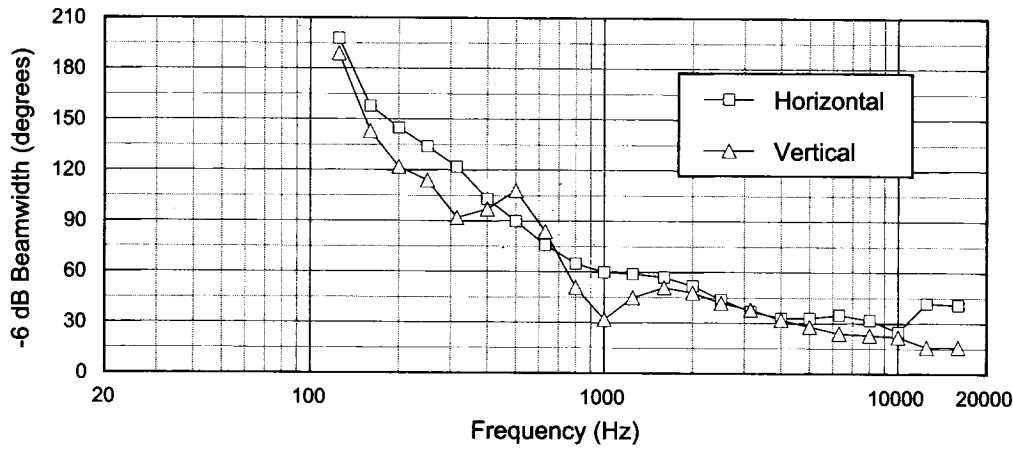

Figure 12. Directivity index and Q, 4895

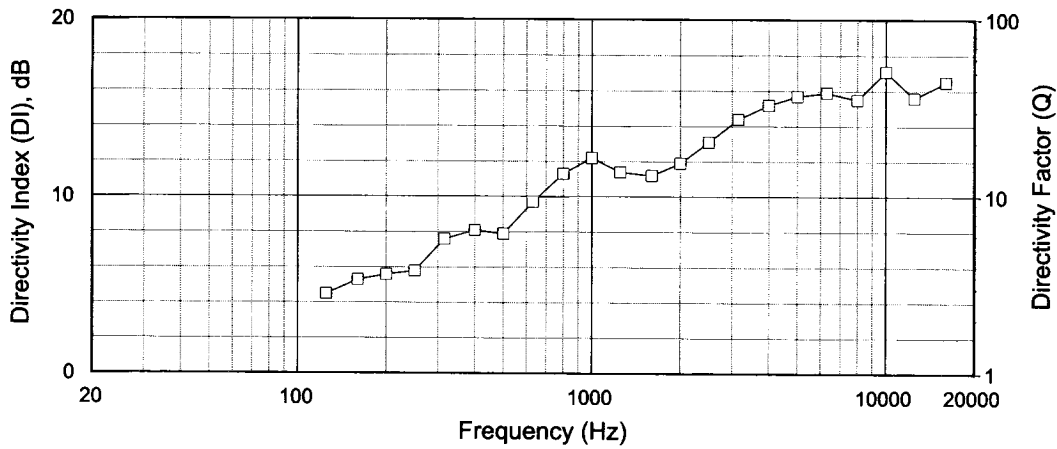

Figure 13. Off-axis response (normalized to 0°) for horizontal, vertical (up), and vertical (down)

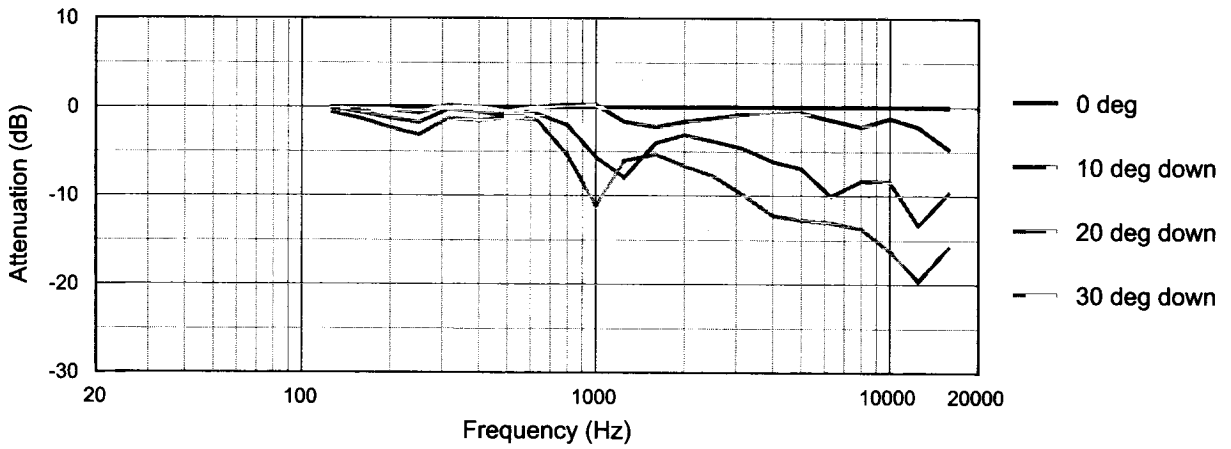
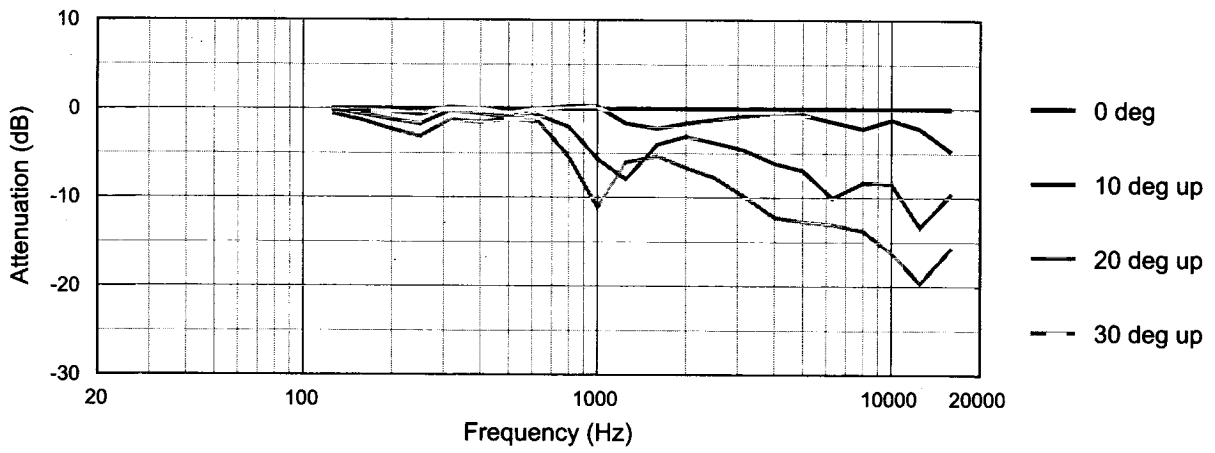
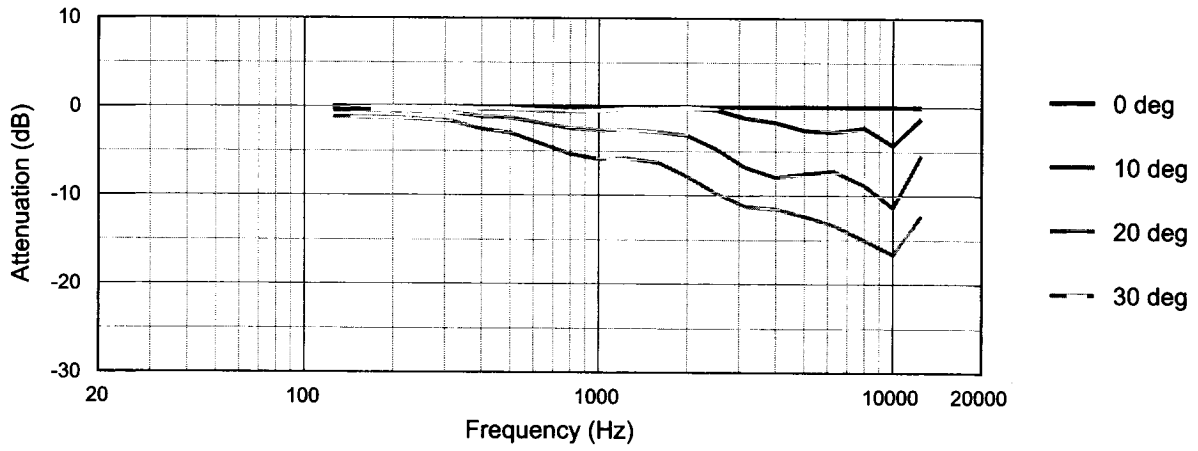

Figure 14. DSC 240 drive curves for 2 x 1 array configuration.

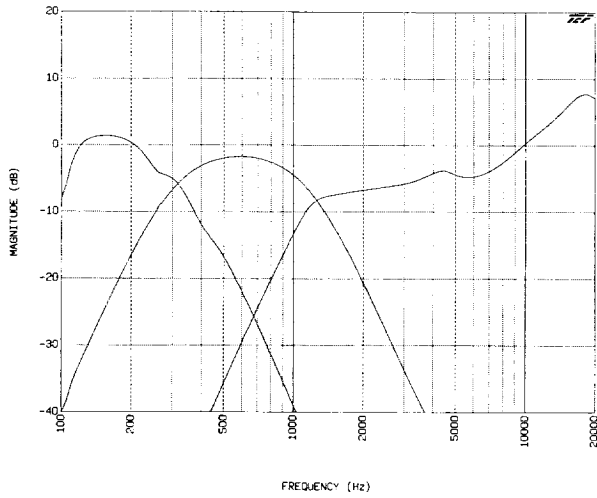

Figure 15. Individual acoustical contributions for the three sections of the HLA system.

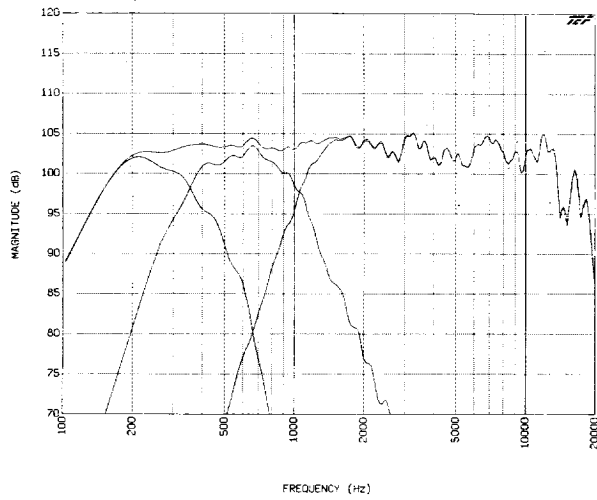
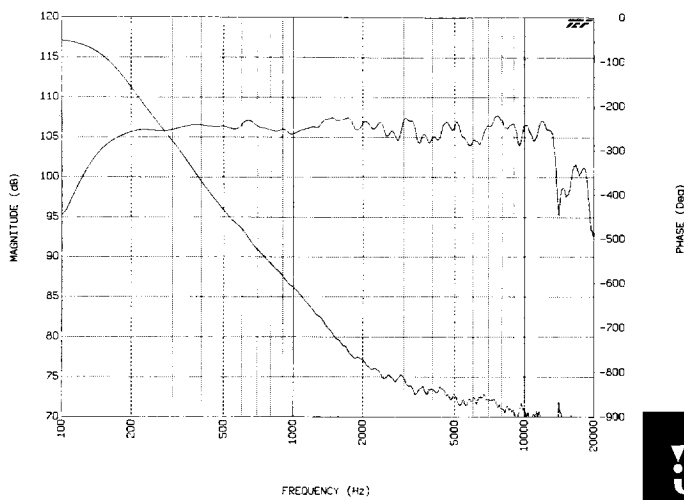

Figure 16. Total acoustical on-axis amplitude and phase response for the HLA system.



JBL Professional
 8500 Balboa Boulevard, P.O. Box 2200
 Northridge, California 91329 U.S.A.
 A Harman International Company

TN VOL 1 NO 23
 CRP 5M
 1/97