



# CBT 1000E

Purpose-Designed Extension  
for CBT 1000 Line Array  
Column Speaker

## CBT SERIES

CONSTANT BEAMWIDTH TECHNOLOGY™

### Key Features:

#### CBT 1000E:

- ▶ Components: Six (6) 165 mm (6.5 in) high-excursion LF drivers
- ▶ 1500 Watt RMS power handling
- ▶ Built-in purpose-designed crossover network for combining with CBT 1000
- ▶ Coupler plate included
- ▶ Doubles power handling and extends pattern control

#### CBT 1000 + 1000E ARRAY SYSTEM:

- ▶ Components: Twenty-four (24) 25 mm (1 in) extra-high-power soft dome tweeters and twelve (12) 165 mm (6.5 in) high-excursion LF drivers
- ▶ Very high sound levels up to 131 dB (137 dB peaks) depending on the settings
- ▶ 1500 Watt RMS power handling
- ▶ Extended pattern control (to 300 Hz for +/- 20 degree control, to 200 Hz for substantial off-axis cancellation)
- ▶ Extended bass response to 38 Hz
- ▶ Patent-pending Constant Beamwidth Technology™ provides constant directivity and reduces out-of-coverage lobing
- ▶ Vertical pattern coverage is individually adjustable through a range of four (4) "Pattern Up" angles and four (4) "Pattern Down" coverage angles for a total of sixteen (16) different coverage combinations, all without the use of external DSP processing
- ▶ Patent-pending Tapered Horizontal Waveguide provides a continuously varying horizontal dispersion (very wide for short-throw, narrower for long-throw) delivering superior coverage in both the front and rear corners of a room
- ▶ Switchable voicing provides flat response in music mode or mid-range presence peak in speech mode
- ▶ 2-piece swivel (pan)/tilt wall bracket and coupler plate included (rear insert-point pattern fits standard third-party brackets)

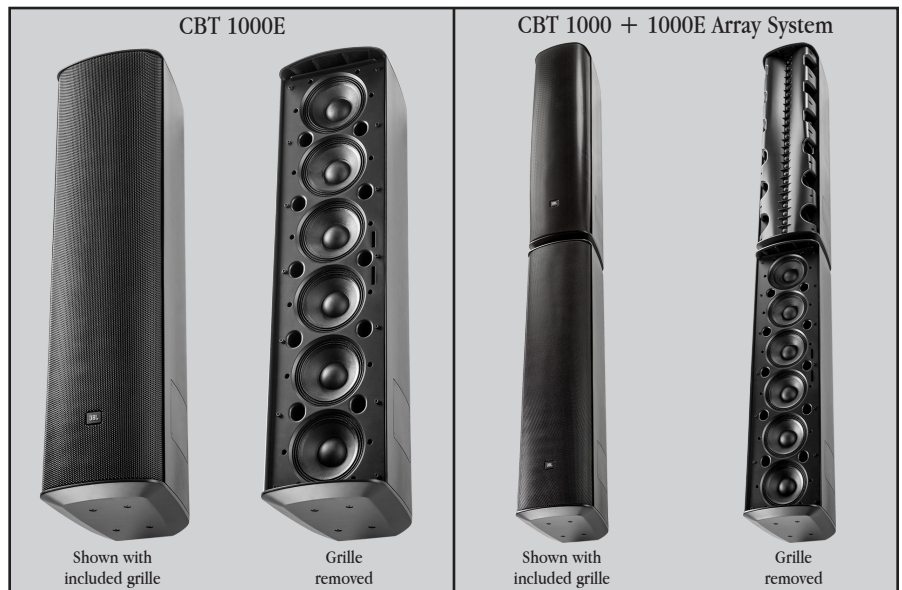

### Overview:

#### CBT 1000E

The CBT 1000E cabinet contains six low frequency drivers and a crossover network purposely designed for use in the CBT 1000 + 1000E system, in a tough fiberglass-reinforced ABS enclosure. The 1500W power handling and high sensitivity delivers powerful low frequency output.

The drivers have neodymium magnet motors with 50 mm (2 in) diameter voice coils. The magnet system provides maximum flux in a compact package. The magnetic structure is magnetically shielded and the copper pole tips reduce flux modulation and minimize distortion. The 16 mm (0.62 mm) long coil provides higher linear drive and high power handling in a compact driver. The drivers feature damped blended surrounds and coated sealed paper cones found in high performance large format drivers. Drivers feature coated diaphragm materials to provide moisture, UV and salt resistance for outdoor capability. The thick heavy-duty aluminum grille allows for rust-free installation outdoors.

#### CBT 1000 + 1000E ARRAY SYSTEM

When connected to a CBT 1000 line array column speaker, the CBT 1000E Extension provides extended bass response, extended pattern control, and increased sound output levels. The combined array system provides Constant Beamwidth Technology™, which represents a breakthrough in pattern control consistency, utilizing complex analog beam-forming to accomplish superior, consistent vertical coverage without the narrow vertical beaming and out-of-coverage lobing that are typical of passive column speakers.

The CBT 1000E attaches to the bottom of the CBT 1000 utilizing the included coupler plate, or to the top of the CBT 1000 (when adding the optional MTC-CBT-OSB3 off-set bracket to align the front grilles), resulting in a very well controlled progressive line array with asymmetrical vertical coverage capability. When in one of the asymmetrical settings, the speaker system produces a higher concentration of sound with a tighter pattern projecting toward the far areas of the listening space. This results in more even front-to-back SPL levels than would be the case from a traditional speaker or column that projects symmetrically.

The CBT 1000 + 1000E System provides a wide 38 Hz – 20 kHz bandwidth, and the slim footprint fits well into virtually any architectural décor. The 2040 mm (80.4 in) tall line array height provides consistent pattern control throughout the intelligibility band, making the System work well for difficult acoustic environments.

# CBT 1000E Purpose-Designed Extension for CBT1000 Line Array Column Speaker

---

## Applications

Combining superior sound quality, excellent pattern control, asymmetrical vertical coverage, continuously tapered horizontal dispersion, and compact design makes the CBT 1000 + 1000E System ideal for applications such as performance auditoriums, houses of worship, lecture halls, classrooms, cinema main speakers or very high-output surrounds, multipurpose spaces, A/V, transit centers, sports facilities, racetracks, theme parks, outdoor locations, and high-level fill applications among many others.

## Adjustable Coverage to Fit the Application

Innovative vertical pattern coverage adjustability allows the installer to switch through a range of four (4) "Pattern Up" coverage angles and four (4) "Pattern Down" coverage angles for a total of sixteen (16) different coverage combinations, all without the use of external DSP processing. Additionally, the use of a patent-pending Tapered Horizontal Waveguide provides a continuously varying horizontal dispersion (very wide for short-throw, narrower for long-throw) delivering superior coverage in both the front and rear corners of a room. These unique features allow the user to match the coverage and throw requirements of the application, and the coverage selection can be easily switched in-venue with the speaker already installed. These innovations allow a single loudspeaker model to excel in an extremely wide variety of project types.

## User Variable Voicing

The voicing can be set to match the application through a Music/Speech switch. The Music setting provides flat frequency response, while the Speech setting produces a mid-range presence boost to provide clear, intelligible speech even at the longest throw distances, along with increased midrange sensitivities for higher midrange maximum output capability.

## Drivers

The low frequency drivers feature lightweight neodymium motors with 50 mm (2.0 in) diameter voice coils. The magnet system provides maximum flux in a compact package. The magnet structure is magnetically shielded and the drivers have a copper cap on the pole to minimize flux modulation and linearize inductance, resulting in lower distortion and improved frequency response. The 16 mm (0.63 in) long coil provides high linear drive and high power handling in a compact driver. The LF drivers feature damped blended textile surrounds and coated sealed paper cones found in high performance large format drivers.

The high frequency drivers include neodymium structure for maximum sensitivity, and feature high power handling, long excursion and large back enclosures for additional frequency range and output. The tweeter is encased for weather resistance.

Both drivers feature coated diaphragm materials to provide moisture, UV and salt resistance for outdoor capability.

## SonicGuard™

Dynamic SonicGuard™ protection on the high frequency section minimizes distortion at high drive levels by limiting driver excursion dynamically. This maximizes music clarity and speech intelligibility at high drive levels while protecting the drivers from damage due to occasional overpowering.

## Bracketry

A two-part swivel (pan) / tilt wall-mount bracket is included. Fourteen (14) M8 brass inserts are located on the back panel in a spacing pattern that fits common third-party mounting brackets. In addition, four insert points each are located on the top and bottom end-caps. These insert points can be utilized to suspend the speaker using forged shoulder steel eyebolts or swivel mounting rings, providing installation versatility. Optional brackets include MTC-CBT-FM3 (in MTC-CBT1K-ACC1 kit) for flush-mounting the back of the speaker to a wall, and MTC-CBT-SUS3 CBT Series suspension bracket kit.

## Outdoor Capability

CBT 1000 can be installed either indoors or outdoors. The drivers are weather-treated, the fiberglass reinforced ABS cabinet is excellent for outdoor applications, and the paint is UV resistant. External screws are stainless steel and the powder coated 1050 aluminum grille resists rust in the harshest of conditions.

## Color

Available in black (RAL9004) or White (-WH) (RAL9016).

# CBT 1000E Purpose-Designed Extension for CBT1000 Line Array Column Speaker

## Specifications:

---

### CBT 1000E EXTENSION LOUDSPEAKER

---

Components: Six (6) 165 mm (6.5 in) LF drivers

Frequency Range (-10 dB)<sup>1</sup>: 38 Hz – 650 Hz

Sensitivity (2.83V@ 1m)<sup>1,2</sup>: 92 dB full space, 98 dB half-space (65 Hz – 300 Hz)

Nominal Impedance: 8 ohms

Power Capacity<sup>3</sup>: 1500 W (6000 W peak), 2 hrs  
900 W (3600 W peak), 100 hrs

Maximum Input Voltage: 65 Volts RMS (2 hrs), 130 Volts Peak (when powered separately, not in parallel with CBT 1000)

Max SPL<sup>4</sup>: 124 dB full space, 130 dB half-space (65 Hz – 300 Hz)

Net Weight: 20 kg (44 lbs)

Shipping Weight: 30 kg (66 lbs)

---

### CBT 1000 + 1000E SYSTEM (connected-to-end, driven in parallel)

---

Components: Twelve (12) 165 mm (6.5 in) LF drivers  
Twenty-four (24) 25 mm (1 in) HF drivers

Frequency Range (-10 dB)<sup>1</sup>: 38 Hz – 20 kHz

Coverage: Vertical (selectable via switch)

Sensitivity (2.83V@ 1m)<sup>1,2</sup>: 102 dB (at highest sensitivity setting: “Point” pattern up, “Point” pattern down, “Speech” voicing, in free space)  
95 dB (at lowest sensitivity setting: “Medium” pattern up, “Downfill” pattern down, “Music” voicing in free space)

Nominal Impedance: 4 ohms

Power Capacity<sup>3</sup>: 1500 W (6000 W peak), 2 hrs  
900 W (3600 W peak), 100 hrs

Maximum Input Voltage: 65.0 Volts RMS (2 hrs), 130.0 Volts Peak when CBT 1000 and CBT 1000E are connected in parallel

Max SPL<sup>4</sup>: Highest directivity setting: (“Point” pattern up, “Point” pattern down) with “Speech” voicing:  
131 dB continuous average pink noise  
134 dB continuous program  
137 dB Peak

Highest directivity setting: (“Point” pattern up, “Point” pattern down) with “Music” voicing:  
127 dB continuous average pink noise  
130 dB continuous program  
133 dB peak

Lowest directivity setting: (“Medium” pattern up, “Downfill” pattern down) with “Speech” voicing:  
128 dB continuous average pink noise  
131 dB continuous program  
134 dB peak

Lowest directivity setting: (“Medium” pattern up, “Downfill” pattern down) with “Music” voicing:  
124 dB continuous average pink noise  
127 dB continuous program  
130 dB peak

---

Vertical Coverage Settings: Coverage is effective (frequency response similar) beyond the traditional -6 dB coverage angles. This is especially useful in compensating for differences in listening distances. Figures show both the -6 dB and -12 dB coverage angles (at 3 kHz). Angles are in reference to cabinet aiming axis.

#### Pattern UP Settings:

“Point”: -6dB @ +7°, -12 dB @ +12°  
“Tight”: -6dB @ +9°, -12 dB @ +15°  
“Narrow”: -6dB @ +10°, -12 dB @ +20°  
“Medium”: -6dB @ +13°, -12 dB @ +24°

#### Pattern DOWN Settings:

“Point”: -6dB @ -7°, -12 dB @ -12°  
“Narrow”: -6dB @ -10°, -12 dB @ -20°  
“Broad”: -6dB @ -17°, -12 dB @ -28°  
“Downfill”: -6dB @ -20°, -12 dB @ -35°

---

# CBT 1000E Purpose-Designed Extension for CBT1000 Line Array Column Speaker

Horizontal Coverage: Patent-pending Tapered Horizontal Waveguide continuously variable.

Long-throw (top) section: 100°  
 Middle section: 130°  
 Short-throw (bottom) section: 160°

Recommended High-Pass: 35Hz, 24 dB/oct or greater

## Transducers:

Low Frequency Drivers: 12 pcs, 165 mm (6.5 in) drivers, neodymium, 50 mm (2 in) voice coil, damped blended textile surround, coated diaphragm for moisture, UV, and salt resistance.

High Frequency Drivers: 24 pcs, 25 mm (1 in) drivers, neodymium, encased magnet and coated diaphragm for moisture, UV, and salt resistance.

## Enclosure:

Enclosure: Fiberglass reinforced ABS cabinet, powder coated 1050 aluminum grille

Outdoor Capability: IP-55 rated, per IEC529, when installed with optional MTC-PC2 panel cover. Exceeds Mil Spec 810 for humidity, temperature & UV, ASTM G85 for acid-air/salt-spray (200 hrs).

Colors: Black (RAL9004) or White (-WH) (RAL9016)

Insert Points: Coupler plate utilizes the bottom two rows of the top speaker and the top two rows of the bottom speaker, leaving available: 20 individual M8 inserts on back panel (20 mm deep) for use with swivel (pan)/tilt bracket(s), plus 4 individual M8 inserts on top and 4 on bottom of cabinet end-caps.

Mounting: Included two-part swivel (pan)/tilt wall bracket provides continuously variable +/- 45 degree left-right swivel aiming (at no up/down tilt – see Bracket Guide for maximum swivel range at various up/down tilt angles), continuously variable +/- 5.25 degree tilt, in the following increments: 5.25°, 5.0°, 4.5°, 4°, 3.75°, 3.5°, 3.0°, 2.75°, 2.5°, 2.0°, 1.75°, and 1.25°. Twenty (20) available threaded mounting points located on back panel of cabinet conform to industry standard rectangular 127 x 70 mm (5.0 x 2.75 in) pattern for legacy OmniMount® and other compatible third-party brackets. Four (4) threaded mount points on the top end-cap and four (4) on the bottom end-cap. Threaded mounting points can be utilized for suspension. (Always use multiple mounting points.)

Dimensions (H x W x D): 2040 mm x 250 mm x 345 mm  
 (80.4 x 9.9 x 13.6 in)

Net Weight (cabinet): 47.2 kg (104 lbs)

Included Accessories: Two-piece swivel (pan)/tilt wall bracket  
 Coupler Plate

Optional Accessories: MTC-PC2 terminal panel cover  
 MTC-CBT1K-ACC1 Accessory kit includes:  
 2 pcs MTC-CBT-FM3 flush-mount brackets  
 1 pc MTC-CBT-OS3 offset bracket (for CBT 1000+1000E array – works in conjunction with CBT 1000E's included Coupler Plate for locating CBT 1000E extension cabinet above CBT 1000 instead of below it)  
 MTC-CBT-SUS3 CBT Series suspension bracket kit (2 pcs included to provide top and bottom attachment points)

<sup>1</sup>Full space

<sup>2</sup>2.83V @ 1 meter, averaged 2 kHz to 6 kHz; same sensitivity in this range for CBT 1000 alone and CBT 1000+CBT 1000E (for more information see notes in FAQ); Subtract 3 dB for 2.00V @ 1 meter sensitivity.)

<sup>3</sup>IEC standard, full bandwidth pink noise with 6 dB crest factor.

<sup>4</sup>2 kHz - 6 kHz, calculated based on power rating and measured sensitivity, exclusive of power compression.

JBL continually engages in research related to product improvement.

Changes introduced into existing products without notice are an expression of that philosophy.

## CBT1000E

### Frequency Response (full-space, 4π) and Impedance

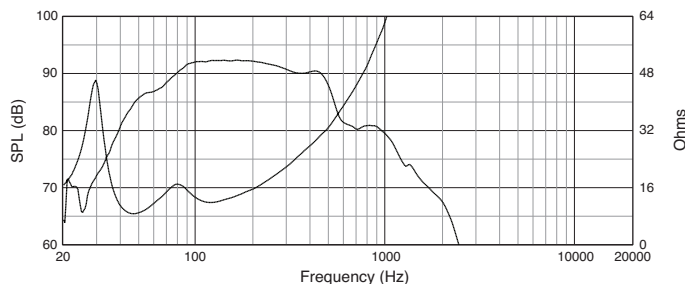

# CBT 1000E Purpose-Designed Extension for CBT1000 Line Array Column Speaker

## Array's Upper-Half Coverage Pattern Selections

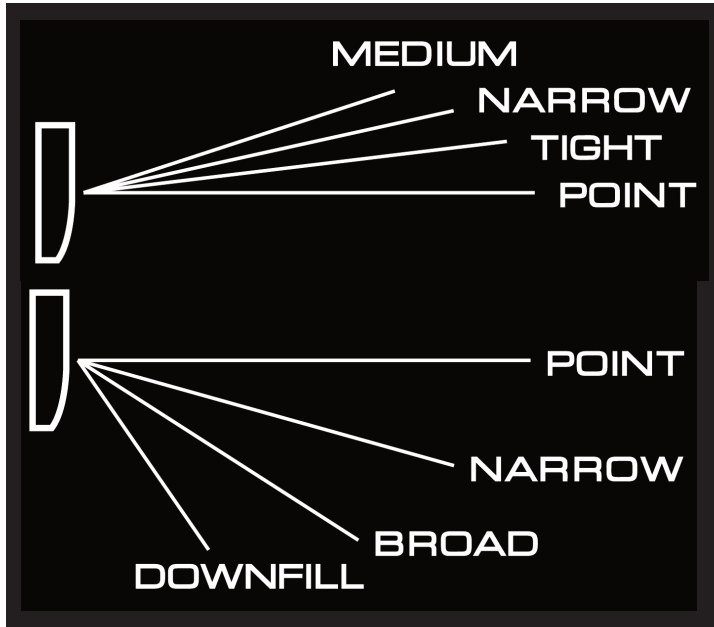

## Array's Lower-Half Coverage Pattern Selections

### Coverage Pattern Selection Panel

Located on side of cabinet; covered by plate. Must remove screws using #1 Phillips head screwdriver, not included.

Position the orange headers to select the coverage patterns and Music/Speech voicing.

(Header positions shown below: Array Upper Half NARROW pattern setting, Array Lower Half DOWNFILL pattern setting, and MUSIC/FLAT EQ [Voicing] setting.)

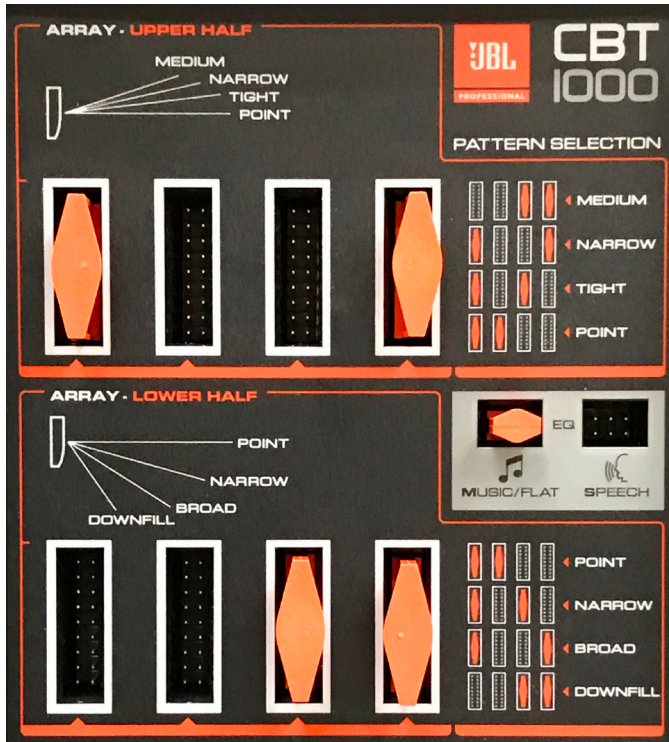

# CBT 1000E Purpose-Designed Extension for CBT1000 Line Array Column Speaker

## CBT 1000 + 1000E System

**Pattern: Up “Medium”;Down “Downfill”**  
(widest vertical setting; asymmetrical)

**Frequency Response & Impedance:**

Sensitivity 2.83V @ 1m, and Impedance

“Music” mode (solid) “Speech” Mode (dotted)

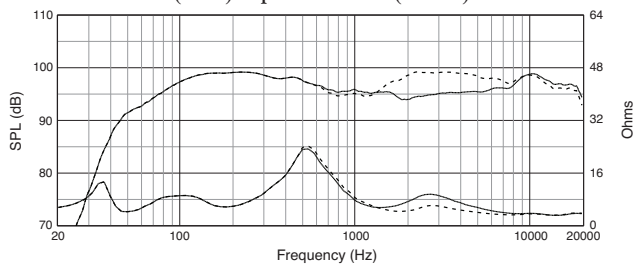

**Beamwidth:**

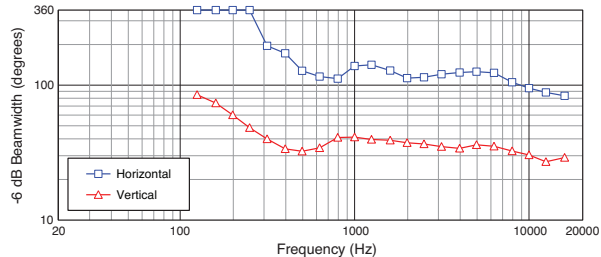

**Vertical Off-Axis Frequency Response, Up:**

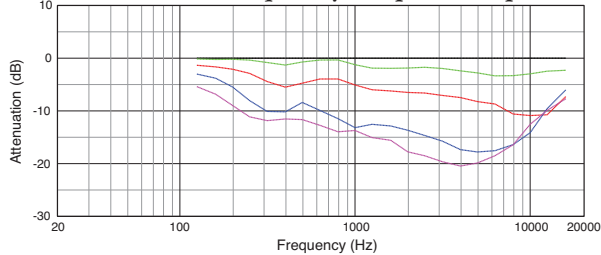

**Vertical Off-Axis Frequency Response, Down:**

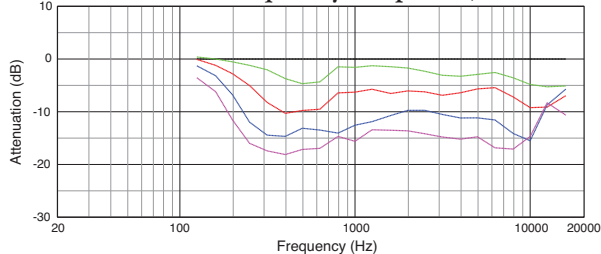

**Horizontal Off-Axis Frequency Response:**

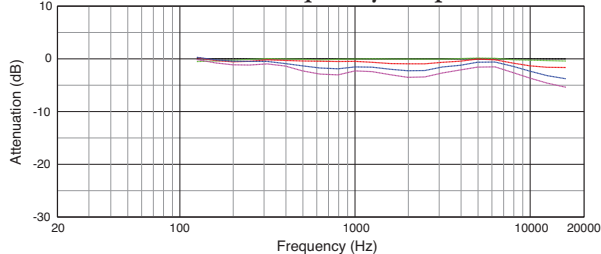

**Pattern: Up “Narrow”;Down “Broad”**  
(medium vertical setting; asymmetrical)

**Frequency Response & Impedance:**

Sensitivity 2.83V @ 1m, and Impedance

“Music” mode (solid) “Speech” Mode (dotted)

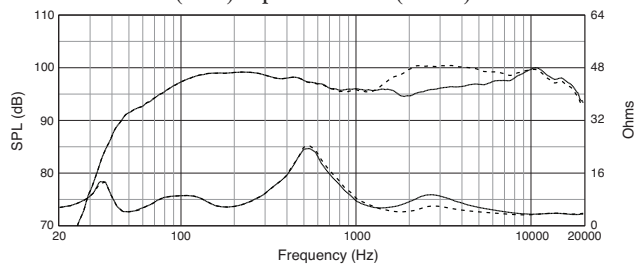

**Beamwidth:**

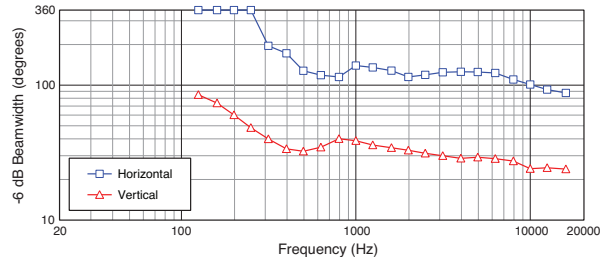

**Vertical Off-Axis Frequency Response, Up:**

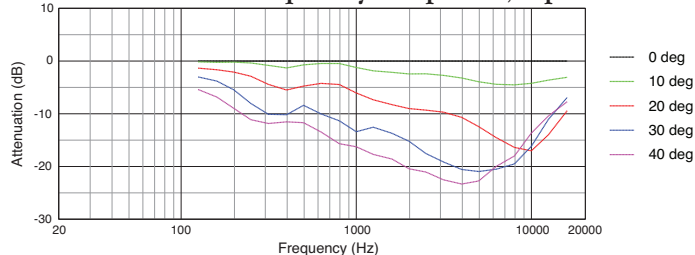

**Vertical Off-Axis Frequency Response, Down:**

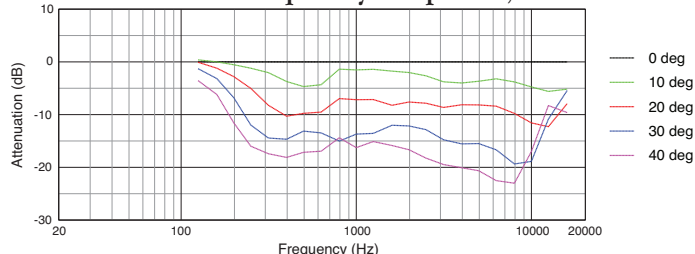

**Horizontal Off-Axis Frequency Response:**

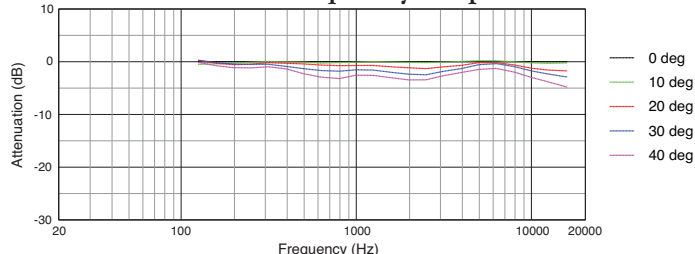

# CBT 1000E Purpose-Designed Extension for CBT1000 Line Array Column Speaker

## CBT 1000 + 1000E System

**Pattern: Up “Tight”;Down “Narrow”**  
(tight vertical setting; asymmetrical)

**Frequency Response & Impedance:**

Sensitivity 2.83V @ 1m, and Impedance  
“Music” mode (solid) “Speech” Mode (dotted)

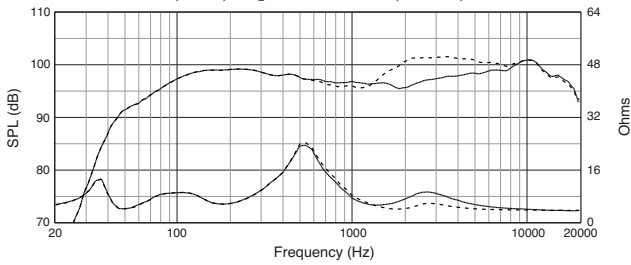

**Beamwidth:**

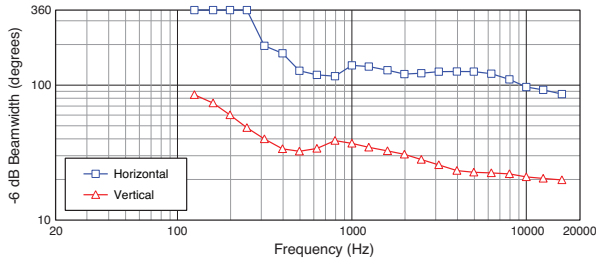

**Vertical Off-Axis Frequency Response, Up:**

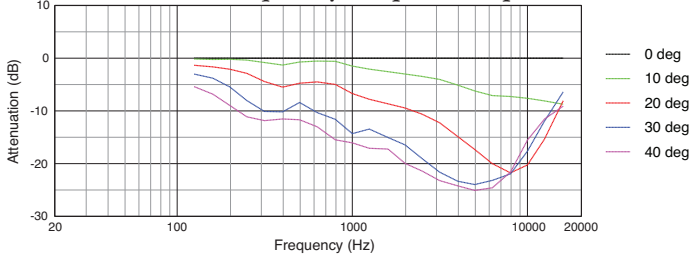

**Vertical Off-Axis Frequency Response, Down:**

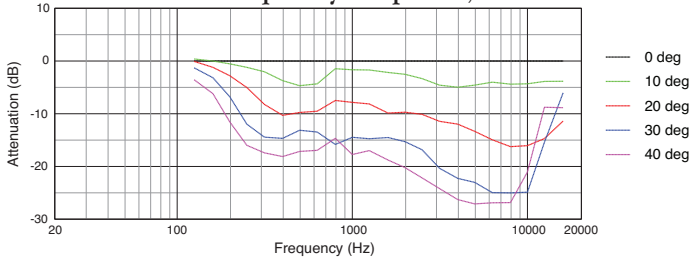

**Horizontal Off-Axis Frequency Response:**

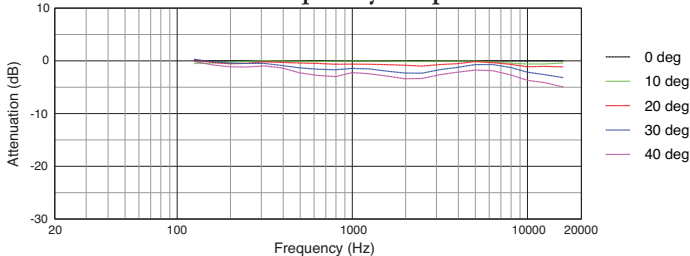

**Pattern: Up “Point”;Down “Point”**  
(tightest vertical setting; symmetrical)

**Frequency Response & Impedance:**

Sensitivity 2.83V @ 1m, and Impedance  
“Music” mode (solid) “Speech” Mode (dotted)

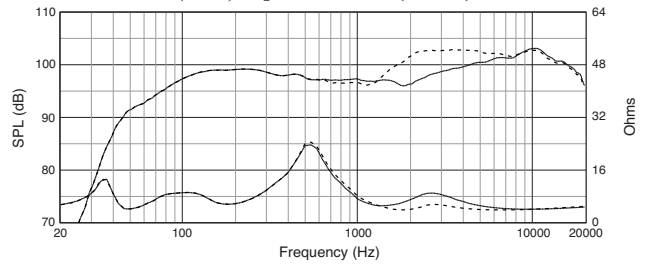

**Beamwidth:**

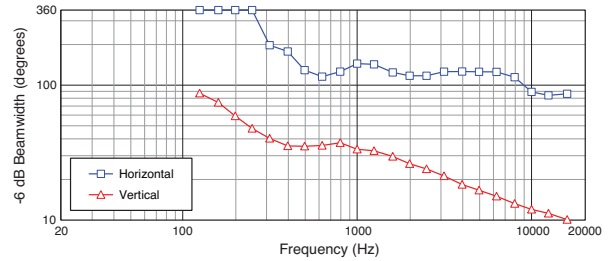

**Vertical Off-Axis Frequency Response, Up:**

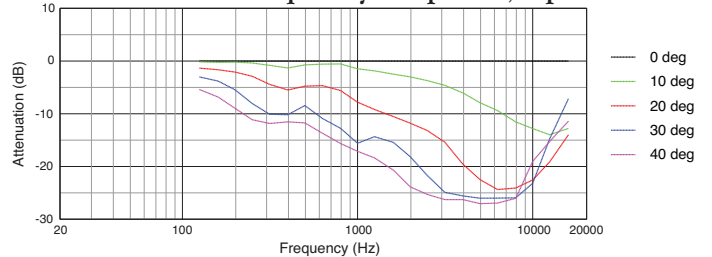

**Vertical Off-Axis Frequency Response, Down:**

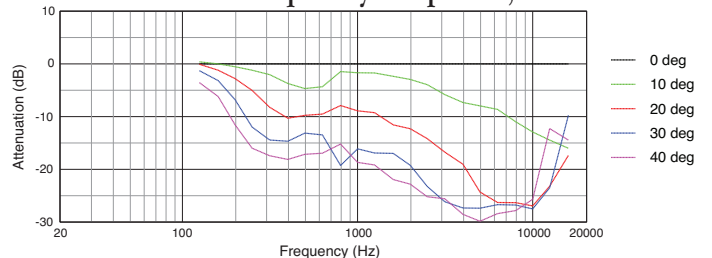

**Horizontal Off-Axis Frequency Response:**

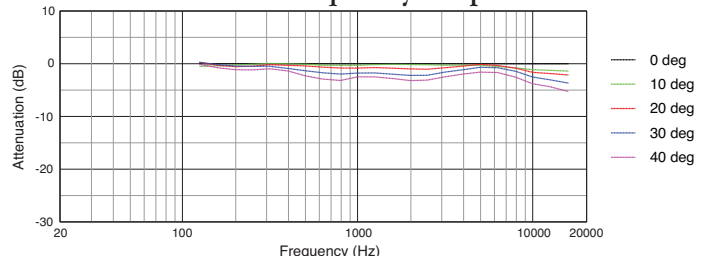

# CBT 1000E Purpose-Designed Extension for CBT1000 Line Array Column Speaker

## Horizontal Beamwidth

Curves below show beamwidth of tweeter 4th from the top of the array, 12th from the top of the array, from the middle of the array, and 4th from the bottom of the array respectively.

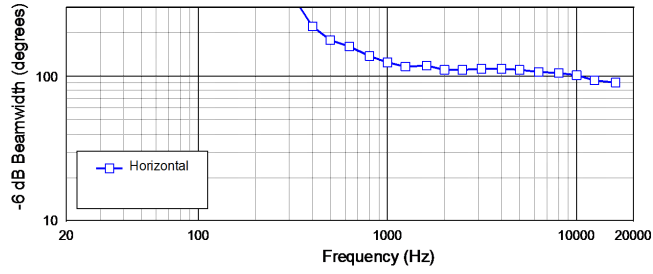

100 Degrees

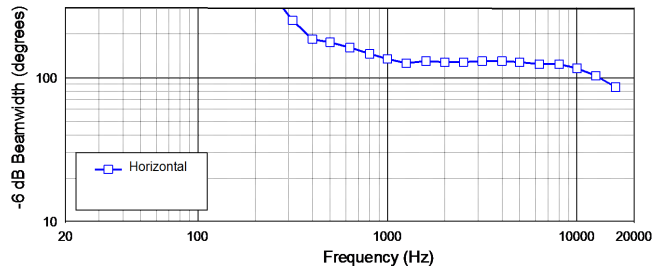

130 Degrees

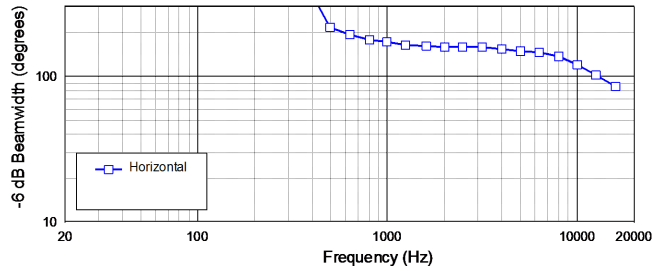

160 Degrees

# CBT 1000E Purpose-Designed Extension for CBT1000 Line Array Column Speaker

## Dimensions

Dimensions in mm [in]

CBT 1000E

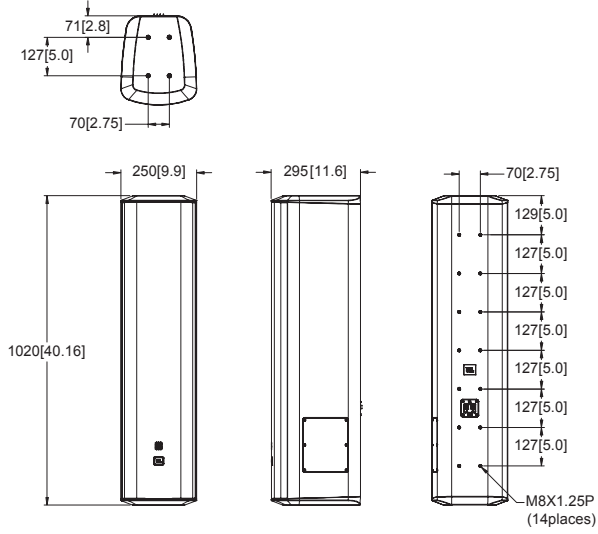

CBT 1000 + 1000E System

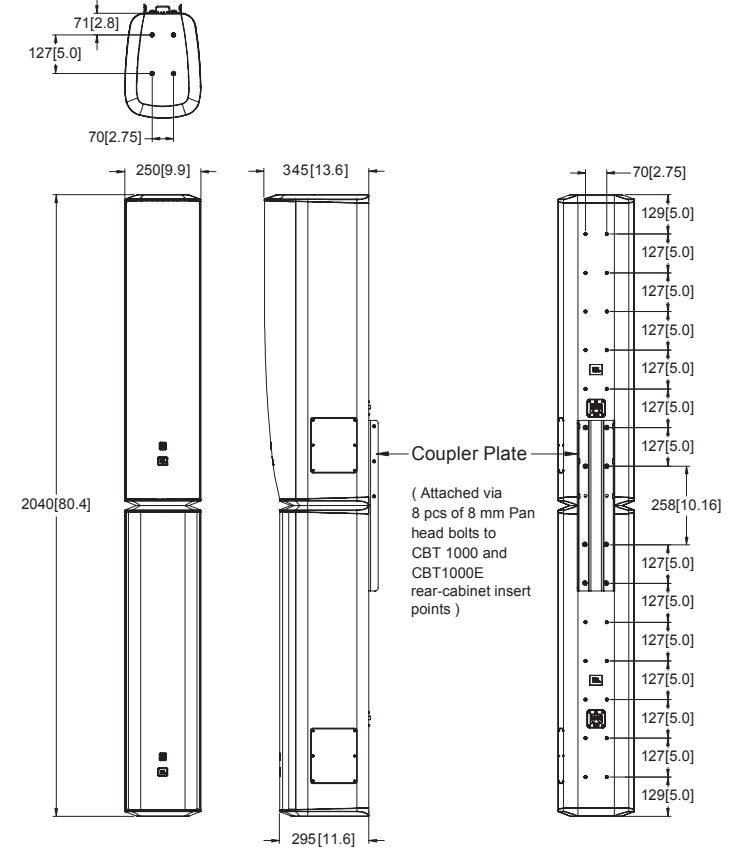

## With Included Two-Piece Wall-Mount Bracket

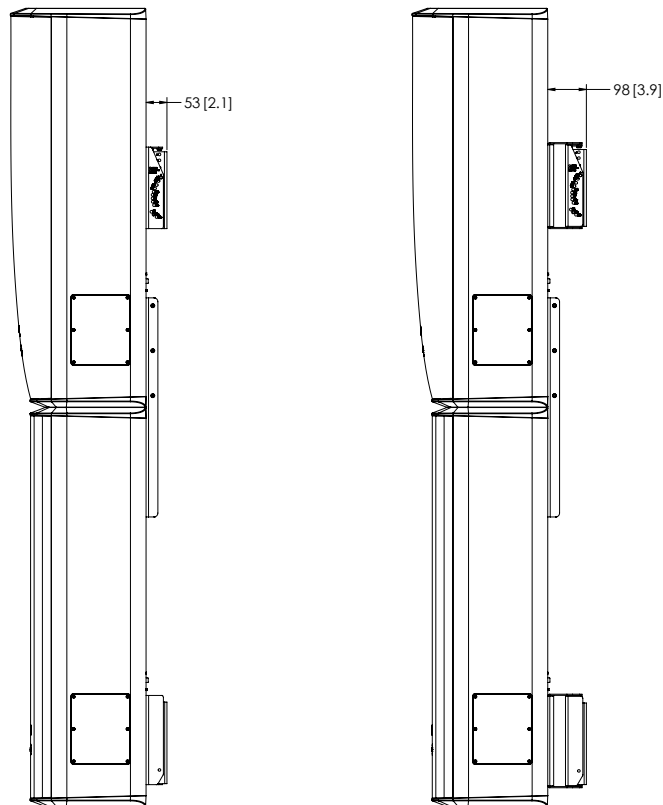

Shown Without Included Swivel Part  
(no horizontal panning)

Shown With Included Swivel Part  
(for +/- 45 degree horizontal panning)

# CBT 1000E Purpose-Designed Extension for CBT1000 Line Array Column Speaker

## Exploded View Diagram of Included Swivel (Pan) / Tilt Bracket

(Diagram is example only. Consult JBL CBT 1000 Bracket Installation Guide for detailed installation instructions)

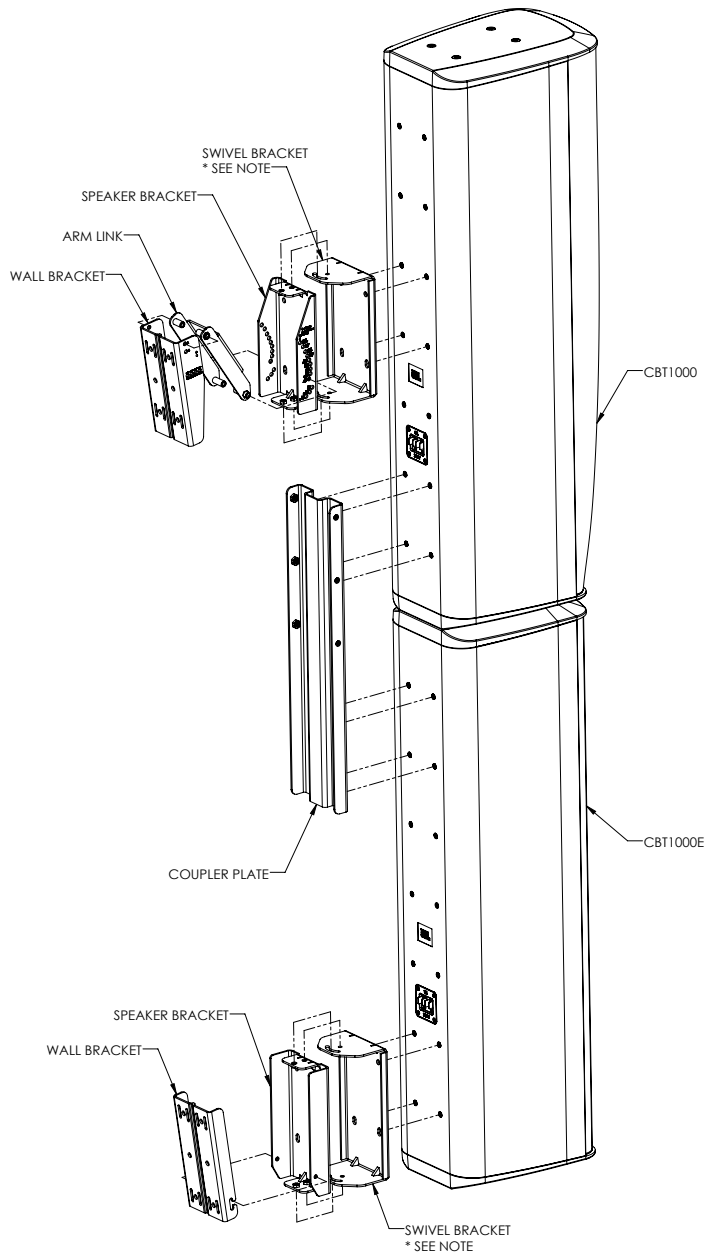

\* NOTE: Use SWIVEL BRACKETS when panning is needed for aiming speaker horizontally. When panning is not needed, leave SWIVEL BRACKETS out, and mount SPEAKER BRACKET directly to CBT 1000 cabinet. Diagram is example only. Consult JBL CBT 1000 Bracket Installation Guide for detailed installation instructions.



JBL Professional  
8500 Balboa Boulevard  
Northridge, California 91325 U.S.A.

© Copyright 2026 JBL Professional  
[www.jblpro.com](http://www.jblpro.com)

SS CBT1K+E REV B  
03/26