



AWC129

All-Weather Compact 2-Way Coaxial Loudspeaker with 12" LF

Professional Series

Key Features:

- ▶ Highly weather-resistant IP56 rating.
- ▶ Consistent 90° x 90° broadband pattern control.
- ▶ Components:
 - 300 mm (12 in) woofer with Kevlar-reinforced cone and 75 mm (3 in) voice coil.
 - 25 mm (1 in) exit compression driver with unique patented design and high temperature polymer diaphragm.
- ▶ Extraordinary clarity for speech, with extended frequency response for music.
- ▶ Advanced high-slope crossover network for constant coverage and smooth, natural midrange.
- ▶ 400 Watt power handling (average continuous pink noise) with high sensitivity provides high SPL capability.
- ▶ High-power passive crossover network.
- ▶ Overload protection.
- ▶ 55 Hz – 20 kHz frequency response.
- ▶ 200 Watt 70V/100V multi-tap (built-in transformer) or direct 8Ω low-impedance.

Applications:

The AWC129 is a compact, coaxial-driver, 2-way, highly weather-resistant full-range loudspeaker system which is ideal for speech and music in a wide variety of applications, including sports facilities, racetracks, stadiums, fairgrounds, rodeos, skating rinks, themed entertainment venues, water parks, outdoor background music/paging systems, swimming pools, and a wide variety of other outdoor or indoor venue types.

The AWC129 is comprised of a high-power coaxial 300 mm (12 in) low frequency driver and 25 mm (1 in) high frequency compression driver. The co-axial design utilizes a unique tapered polepiece design and transitions to the cone of the low frequency driver as a large diameter pattern control horn for the high frequencies, both eliminating high-frequency beaming which is common among this category of speaker and extending pattern control to the lowest possible frequencies. The result is a coaxial speaker with wide, extremely consistent 90° coverage on a broadband basis.

Component features include a Kevlar-reinforced low frequency cone for reliability, well-damped surround for smooth frequency response, high temperature 75 mm (3 in) voice coil and a reduced distortion design through saturated-gap magnet geometry. The high frequency compression driver features a unique patented design, high temperature polymer diaphragm, and fluid-cooling for high output levels with low distortion.

The paintable enclosure is constructed of thick ABS plus fiberglass and is heavily braced to maximize low-frequency performance. The corrosion-resistant zinc-rich extra-thick powder coated steel grille is backed with open cell foam and high thread-count mesh, providing excellent protection in the harshest environments. The system is rated IP-56, per IEC529 when installed at minimum 5° down-tilt.

The system is equipped with a 200W 70V/100V multi-tap transformer. Connection is made via outdoor-rated terminals in a recessed terminal cup. A protective terminal compartment cover is included, along with gland nut, which forms a water-tight seal with round-jacketed cable having The high frequency compression driver features a unique patented design, high temperature polymer diaphragm, and fluid-cooling for high output levels with low distortion.

A heavy-duty weather-capable zinc-rich, thick powder coated U-type mounting bracket is included.



Specifications:

System:	
Frequency Range (-10 dB):	55 Hz – 20 kHz
Frequency Response (±3 dB):	80 Hz – 20 kHz
Coverage Pattern:	90° x 90°
Directivity Factor:	10.1 (1 k – 16 kHz)
Directivity Index (DI):	9.5 dB (1 k – 16 kHz)
Long-Term System Power Rating (IEC):	400 W (1600 W peak), 2 hrs. 250 W (1000 W peak), 100 hrs
Sensitivity (2.83V @ 1m):	96 dB (Ave. 80 Hz – 20 kHz)
Maximum SPL:	Direct 8Ω: 122 dB (peaks of 124 dB) 200 W Tap: 119 dB
Crossover Network:	1.5 kHz, 3rd order (18 dB/oct) high-pass plus conjugate to HF, 2nd order low-pass to LF
Nominal Impedance:	8 ohms
Transformer Taps:	70V: 200W, 100W, 50W, 25W 100V: 200W, 100W, 50W
Transducers:	
Low Frequency Driver:	Kevlar-reinforced cone with weather treatment, 75 mm (3 in) voice coil.
High Frequency Driver:	25 mm (1 in) diaphragm and voice coil diameter, high temperature polymer diaphragm, patented design, fluid-cooling.
HF Driver Protection:	Minimum audibility SonicGuard™ HF overload protection
Physical:	
Enclosure:	ABS with Glass enclosure, heavily braced
Attachment:	Two M10 (fine-thread) points for included U-bracket. Reference torque 15 ft-lb (20 N·m). M6 secondary safety attachment point on back panel.
Grille:	Corrosion-resistant zinc-rich extra-thick powder coated steel grille, 3-layer assembly with foam and woven poly mesh backing.
Input Connection:	CE-compliant covered barrier strip terminals. Barrier terminals accept up to 8 mm outside 4 mm inside open-lug (#6 or #8) plus bare wire up to 2.5 mm ² (12 AWG) wire or spade lugs. Terminal compartment cover equipped with gland nut that forms water-tight seal with round-jacketed cables with outside diameters between 4.0 mm (0.16") and 9.0 mm (0.36").
Environmental:	IP56 per IEC529, with a minimum 5° downward aiming angle. Exceeds Mil Spec 810 for humidity, salt spray, temperature & UV, and ASTM G85 for acid-air/salt-spray (336 hrs).
Dimensions:	402 x 402 x 445 mm (15.8 x 15.8 x 17.5 in), cabinet 470 mm (18.5 in) depth including gland nut 542 mm (21.4 in) including bracket extending to back
Colors:	Available in gray (similar to Pantone 420C) and black (-BK)
Net Weight:	15.9 kg (35.0 lb), 18.9 kg (41.5 lb) with U-bracket
Shipping Weight:	23.4 kg (51.5 lb)
Included Accessories:	U-bracket, matches loudspeaker color (gray or black), zinc-rich extra thick powder coated, steel.

¹ Full-space (free-field)

² Average 1 kHz to 10 kHz

³ IEC standard, full bandwidth pink noise with 6 dB crest factor.

⁴ Calculated based on power rating and measured full-space sensitivity.

► AWC129 All-Weather Compact 2-Way Coaxial Loudspeaker with 12" LF

Frequency Response and Impedance

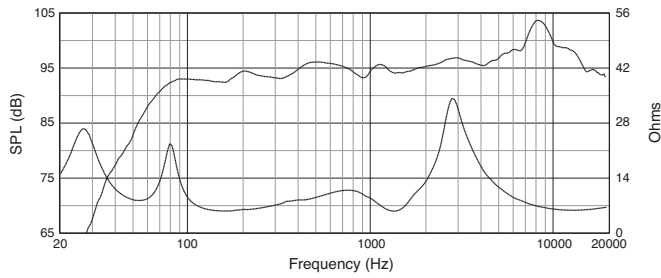

Off-Axis Frequency Response

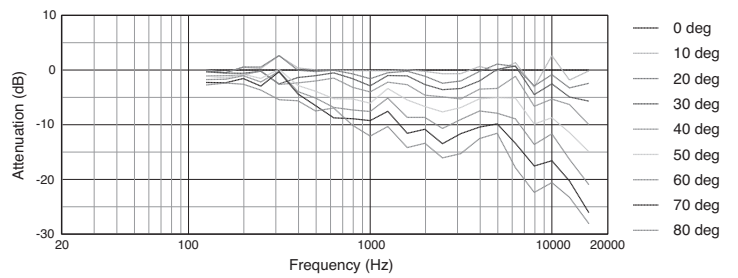

Beamwidth

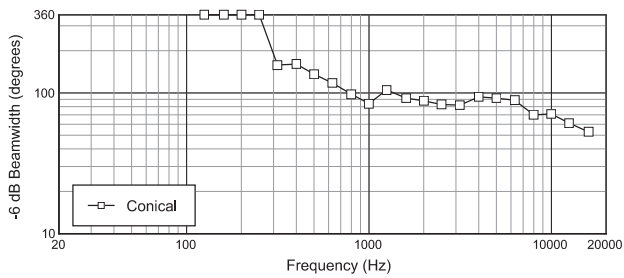

Directivity Index

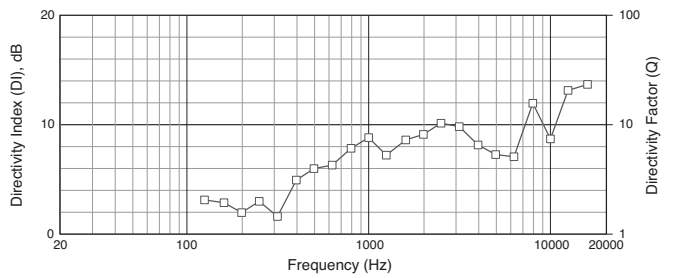

Dimensions

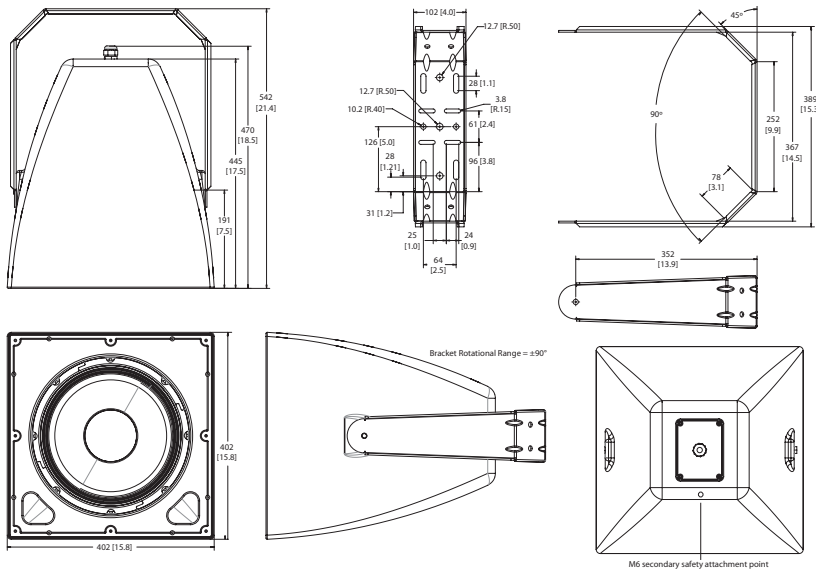

Attaching U-Bracket to Cabinet

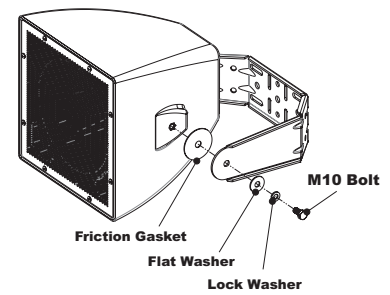

Terminal Compartment

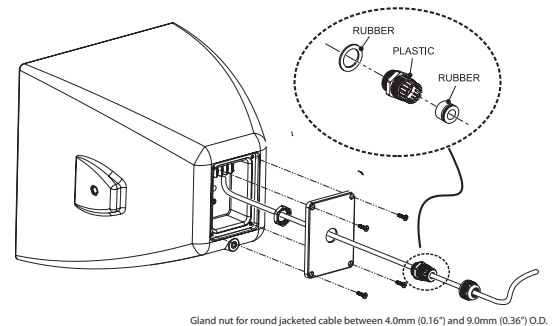

JBL Professional
 8500 Balboa Boulevard, P.O. Box 2200
 Northridge, California 91329 U.S.A.
 © Copyright 2024 JBL Professional
 www.jblpro.com

SS AWC129
 04/2024